



Bring joy and happiness
to your loved ones



- Lowerlimbs prosthetics components
- Suspension system
- Cosmetics, Tools and Materials
- Orthotics and Rehabilitation products
- Upperlimbs prosthetics components

REGAL Prosthesis Ltd.

Your reliable partner

2018

Version 8.0

Contents

Index	P.2-8
Regal Pediatric	P.9-18
Regal Feet and Adaptors	P.19-38
Regal Knee joints and Hip Joints	P.39-56
Regal Suspension Systems	P.57-76
Regal Cosmetic, Tools and Materials	P.77-100
Regal Orthotics and Rehabilitation	P.101-110
Regal Upperlimbs Modular Prosthesis	P.111-114
Regal FAQ & Warranty	P.115

Our Quality Management System and Product Certification:



ISO13485:2016
Design and manufacture of
Silicone Cosmetic Prostheses
and Supply of Prosthetics and
Orthotics products



ISO9001:2015
Quality management system
certification



CE certification

Index

Product Code Pediatric	Page no.
0-00-4S30C	12,42
0-00-4S40C	14,41
0-00-4S40C=LA	14,41
0-00-4S40C-01	14,41
0-00-4S40C-02	14,41
0-00-4S40C=LA-01	14,41
0-00-4S41C	13,40
0-00-4S41C=LA	13,40
0-00-4S41C-01	13,40
0-00-4S41C=LA-01	13,40
0-00-H1C	15,42
0-00-H1C-01	15,42
0-01-FAC	15,76
0-01-FBC	16,77
0-01-FTT-L-15	10,22
0-01-FTT-R-15	10,22
0-01-FTT-L-16	10,22
0-01-FTT-R-16	10,22
0-01-FTT-L-17	10,22
0-01-FTT-R-17	10,22
0-01-FTT-L-18	10,22
0-01-FTT-R-18	10,22
0-01-FTT-L-19	10,22
0-01-FTT-R-19	10,22
0-01-FTT-L-15B	10,22
0-01-FTT-R-15B	10,22
0-01-FTT-L-16B	10,22
0-01-FTT-R-16B	10,22
0-01-FTT-L-17B	10,22
0-01-FTT-R-17B	10,22
0-01-FTT-L-18B	10,22
0-01-FTT-R-18B	10,22
0-01-FTT-L-19B	10,22
0-01-FTT-R-19B	10,22
0-01-FTT-NT-L-12	10,21
0-01-FTT-NT-R-12	10,21
0-01-FTT-NT-L-13	10,21
0-01-FTT-NT-R-13	10,21
0-01-FTT-NT-L-14	10,21
0-01-FTT-NT-R-14	10,21
0-01-FTT-NT-L-15	10,21
0-01-FTT-NT-R-15	10,21
0-01-FTT-NT-L-16	10,21
0-01-FTT-NT-R-16	10,21
0-01-FTT-NT-L-17	10,21
0-01-FTT-NT-R-17	10,21
0-01-FTT-NT-L-12B	10,21
0-01-FTT-NT-R-12B	10,21
0-01-FTT-NT-L-13B	10,21

Product Code Pediatric	Page no.
0-01-FTT-NT-R-13B	10,21
0-01-FTT-NT-L-14B	10,21
0-01-FTT-NT-R-14B	10,21
0-01-FTT-NT-L-15B	10,21
0-01-FTT-NT-R-15B	10,21
0-01-FTT-NT-L-16B	10,21
0-01-FTT-NT-R-16B	10,21
0-01-FTT-NT-L-17B	10,21
0-01-FTT-NT-R-17B	10,21
0-01-RFDC200	17,101
0-01-RFSC200	17,101
0-01-RFSC200DM	17,101
0-01-RLOCC-AL	16,107
0-01-RLOCC-SS	16,107
0-02-2N1SC	12,28
0-02-2N1TC	12,28
0-02-A10AC	11,27
0-02-A1AC	11,27
0-02-A1SC	11,27
0-02-A22C	12,28
0-02-A5AC	11,27
0-02-A6AC	11,27
0-02-BC150	12,31
0-02-BC300	12,31

Product Code Feet & Adaptors	Page no.
1-01-BUMP-BL	26
1-01-BUMP-RE	26
1-01-BUMP-YL	26
1-01-DYNA-L-22	25
1-01-DYNA-R-22	25
1-01-DYNA-L-23	25
1-01-DYNA-R-23	25
1-01-DYNA-L-24	25
1-01-DYNA-R-24	25
1-01-DYNA-L-25	25
1-01-DYNA-R-25	25
1-01-DYNA-L-26	25
1-01-DYNA-R-26	25
1-01-DYNA-L-27	25
1-01-DYNA-R-27	25
1-01-DYNA-L-28	25
1-01-DYNA-R-28	25
1-01-DYNA-L-29	25
1-01-DYNA-R-29	25
1-01-DYNA-L-22B	25

Product Code Feet & Adaptors	Page no.
1-01-DYNA-R-22B	25
1-01-DYNA-L-23B	25
1-01-DYNA-R-23B	25
1-01-DYNA-L-24B	25
1-01-DYNA-R-24B	25
1-01-DYNA-L-25B	25
1-01-DYNA-R-25B	25
1-01-DYNA-L-26B	25
1-01-DYNA-R-26B	25
1-01-DYNA-L-27B	25
1-01-DYNA-R-27B	25
1-01-DYNA-L-28B	25
1-01-DYNA-R-28B	25
1-01-DYNA-L-29B	25
1-01-DYNA-R-29B	25
1-01-DYNA-01	25
1-01-FSTOOL	26
1-01-FS-L-23	26
1-01-FS-R-23	26
1-01-FS-L-24	26
1-01-FS-R-24	26
1-01-FS-L-25	26
1-01-FS-R-25	26
1-01-FS-L-26	26
1-01-FS-R-26	26
1-01-FS-L-27	26
1-01-FS-R-27	26
1-01-FS-L-28	26
1-01-FS-R-28	26
1-01-FS-L-23B	26
1-01-FS-R-23B	26
1-01-FS-L-24B	26
1-01-FS-R-24B	26
1-01-FS-L-25B	26
1-01-FS-R-25B	26
1-01-FS-L-26B	26
1-01-FS-R-26B	26
1-01-FS-L-27B	26
1-01-FS-R-27B	26
1-01-FS-L-28B	26
1-01-FS-R-28B	26
1-01-FT-L-21	24
1-01-FT-R-21	24
1-01-FT-L-22	24
1-01-FT-R-22	24
1-01-FT-L-23	24
1-01-FT-R-23	24
1-01-FT-L-24	24
1-01-FT-R-24	24

Index

Product Code Feet & Adaptors	Page no.
1-01-FT-L-25	24
1-01-FT-R-25	24
1-01-FT-L-26	24
1-01-FT-R-26	24
1-01-FT-L-27	24
1-01-FT-R-27	24
1-01-FT-L-28	24
1-01-FT-R-28	24
1-01-FT-L-29	24
1-01-FT-R-29	24
1-01-FT-L-30	24
1-01-FT-R-30	24
1-01-FT-L-21B	24
1-01-FT-R-21B	24
1-01-FT-L-22B	24
1-01-FT-R-22B	24
1-01-FT-L-23B	24
1-01-FT-R-23B	24
1-01-FT-L-24B	24
1-01-FT-R-24B	24
1-01-FT-L-25B	24
1-01-FT-R-25B	24
1-01-FT-L-26B	24
1-01-FT-R-26B	24
1-01-FT-L-27B	24
1-01-FT-R-27B	24
1-01-FT-L-28B	24
1-01-FT-R-28B	24
1-01-FT-L-29B	24
1-01-FT-R-29B	24
1-01-FT-L-30B	24
1-01-FT-R-30B	24
1-01-FT-01-21	24,94
1-01-FT-01-22	24,94
1-01-FT-01-23	24,94
1-01-FT-01-24	24,94
1-01-FT-01-25	24,94
1-01-FT-01-26	24,94
1-01-FT-01-27	24,94
1-01-FT-01-28	24,94
1-01-FTT-L-20	23
1-01-FTT-R-20	23
1-01-FTT-L-21	23
1-01-FTT-R-21	23
1-01-FTT-L-22	23
1-01-FTT-R-22	23
1-01-FTT-L-23	23
1-01-FTT-R-23	23
1-01-FTT-L-24	23

Product Code Feet & Adaptors	Page no.
1-01-FTT-R-24	23
1-01-FTT-L-25	23
1-01-FTT-R-25	23
1-01-FTT-L-26	23
1-01-FTT-R-26	23
1-01-FTT-L-27	23
1-01-FTT-R-27	23
1-01-FTT-L-28	23
1-01-FTT-R-28	23
1-01-FTT-L-29	23
1-01-FTT-R-29	23
1-01-FTT-L-30	23
1-01-FTT-R-30	23
1-01-FTT-L-20B	23
1-01-FTT-R-20B	23
1-01-FTT-L-21B	23
1-01-FTT-R-21B	23
1-01-FTT-L-22B	23
1-01-FTT-R-22B	23
1-01-FTT-L-23B	23
1-01-FTT-R-23B	23
1-01-FTT-L-24B	23
1-01-FTT-R-24B	23
1-01-FTT-L-25B	23
1-01-FTT-R-25B	23
1-01-FTT-L-26B	23
1-01-FTT-R-26B	23
1-01-FTT-L-27B	23
1-01-FTT-R-27B	23
1-01-FTT-L-28B	23
1-01-FTT-R-28B	23
1-01-FTT-L-29B	23
1-01-FTT-R-29B	23
1-01-FTT-L-30B	23
1-01-FTT-R-30B	23
1-01-FTT-01	23,94
1-01-SS	26
1-01-SSL	26
1-01-TF-23-24	26
1-01-TF-25-26	26
1-01-TF-27-28	26
1-02-2N1A	28
1-02-2N1S	28
1-02-2N1T	28
1-02-2SS-01G	30
1-02-2SS-01B	30
1-02-2SS-01P	30
1-02-2SS-S	30
1-02-2SS-L	30

Product Code Feet & Adaptors	Page no.
1-02-2ST-S	30
1-02-2ST-L	30
1-02-A1A	32
1-02-A1A-01	32
1-02-A1S	32
1-02-A1S-01	32
1-02-A1T	32
1-02-A1T-01	32
1-02-A22	33
1-02-A22-75	33
1-02-A22W	33
1-02-A2A	34
1-02-A2S	34
1-02-A2T	34
1-02-A2ZS	34
1-02-A2ZT	34
1-02-A3S-32	37
1-02-A3S-45	37
1-02-A3S-60	37
1-02-A3S-75	37
1-02-A3T-32	37
1-02-A3T-45	37
1-02-A3T-60	37
1-02-A3T-75	37
1-02-A4S-32	37
1-02-A4S-45	37
1-02-A4S-60	37
1-02-A4S-75	37
1-02-A4T-32	37
1-02-A4T-45	37
1-02-A4T-60	37
1-02-A4T-75	37
1-02-A5A	34
1-02-A5S	34
1-02-A5T	34
1-02-A5ZS	34
1-02-A5ZT	34
1-02-A6A	36
1-02-A6S	36
1-02-A6T	36
1-02-A6TOFF	36
1-02-A6T-WRESIST	29
1-02-A7S	34
1-02-A7T	34
1-02-A8S	32
1-02-A8T	32
1-02-A8ZS	33
1-02-A8ZT	33
1-02-A10S	36

Index

Product Code Feet & Adaptors	Page no.
1-02-A10T	36
1-02-A11ZS	35
1-02-A11ZS-01	35,73
1-02-A11ZT	35
1-02-A12S	35
1-02-A12S-01	35
1-02-A12ZS	35
1-02-A12ZT	35
1-02-A14S	37
1-02-A14T	37
1-02-A15S	37
1-02-A15T	37
1-02-B200	31
1-02-B400	31
1-02-BO200	31
1-02-BO250	31
1-02-BO400	31
1-02-BT200	31
1-02-BT400	31
1-02-C300	32
1-02-C355	32
1-02-DB1	30
1-02-DB1-01	30
1-02-T2A1S-210	30
1-02-T2A1S-410	30
1-02-T2A1T-210	30
1-02-T2A1T-210-WRESIST	29
1-02-T2A1T-410	30
1-02-T2A1T-410-WRESIST	29
1-02-T3S-45	30
1-02-T3S-60	30
1-02-T3S-75	30
1-02-T3T-45	30
1-02-T3T-60	30
1-02-T3T-75	30
1-02-TA1	34
1-02-TO1	32
1-02-TO2	32

Product Code Knee joints & Hip Joints	Page no.
2-01-3S40	53
2-01-3S40-01	53
2-01-4S17	52
2-01-4S17-01	52
2-01-4S1S	54
2-01-4S1S-01	54
2-01-4S1S-02	54
2-01-4S1T	54
2-01-4S1T-01	54
2-01-4S1T-02	54
2-01-4S21	51
2-01-4S21-01	51
2-01-4S22	52
2-01-4S23	51
2-01-4S23-01	51
2-01-4S23-02	51
2-01-4S2S	54
2-01-4S2S-01	54
2-01-4S2S-02	54
2-01-4S2T	54
2-01-4S2T-01	54
2-01-4S2T-02	54
2-01-4S33	52
2-01-4S33-01	52
2-01-4S34	52
2-01-4S3S	50
2-01-4S3T	50
2-01-4S40	52
2-01-4S40-01	52
2-01-4S40J	53
2-01-4S40J-01	53
2-01-A41	49
2-01-A41=LA	49
2-01-A41=SP	49
2-01-A41-01	49
2-01-A41=LA-01	49
2-01-A41=SP-01	49
2-01-KA5	50
2-01-S400	48
2-01-S400-01	48
2-01-S400=LA	48
2-01-S400=LA-01	48
2-01-S400=SP	48
2-01-S400=SP-01	48
2-01-S400L	47
2-01-S400L-01	47
2-01-S400L-02	47
2-01-S400L=LA	47
2-01-S400L=LA-01	47

Product Code Knee joints & Hip Joints	Page no.
2-01-S400L=SP	47
2-01-S400L=SP-01	47
2-01-S500	46
2-01-S500-01	46
2-01-S500=LA	46
2-01-S500=LA-01	46
2-01-S500=SP	46
2-01-S500=SP-01	46
2-01-S600	45
2-01-S600-01	45
2-01-S600=LA	45
2-01-S600=LA-01	45
2-01-S600=SP	45
2-01-S600=SP-01	45
2-01-S700	44
2-01-S700-01	44
2-01-S700=LA	44
2-01-S700=LA-01	44
2-01-S700=SP	44
2-01-S700=SP-01	44
2-01-S700L	43
2-01-S700L-01	43
2-01-S700L-02	43
2-01-S700L=LA	43
2-01-S700L=LA-01	43
2-01-S700L=SP	43
2-01-S700L=SP-01	43
2-02-H1	55
2-02-H1-01	55
2-02-H1S	55
2-02-H1S-01	55
2-02-H1SL-L	56
2-02-H1SL-R	56
2-02-H1SL-01	56

Index

Product Code Suspension Systems	Page no.
3-01-3010C-18	65
3-01-3010C-20	65
3-01-3010C-22	65
3-01-3010C-23.5	65
3-01-3010C-25	65
3-01-3010C-26.5	65
3-01-3010C-28	65
3-01-3010C-30	65
3-01-3010C-32	65
3-01-3010C-34	65
3-01-3010C-36	65
3-01-3010L-18	65
3-01-3010L-20	65
3-01-3010L-22	65
3-01-3010L-23.5	65
3-01-3010L-25	65
3-01-3010L-26.5	65
3-01-3010L-28	65
3-01-3010L-30	65
3-01-3010L-32	65
3-01-3010L-34	65
3-01-3010L-36	65
3-01-3012C-18	64
3-01-3012C-20	64
3-01-3012C-22	64
3-01-3012C-23.5	64
3-01-3012C-25	64
3-01-3012C-26.5	64
3-01-3012C-28	64
3-01-3012C-30	64
3-01-3012C-32	64
3-01-3012C-34	64
3-01-3012C-36	64
3-01-3012L-18	64
3-01-3012L-20	64
3-01-3012L-22	64
3-01-3012L-23.5	64
3-01-3012L-25	64
3-01-3012L-26.5	64
3-01-3012L-28	64
3-01-3012L-30	64
3-01-3012L-32	64
3-01-3012L-34	64
3-01-3012L-36	64
3-01-3020C-18	66
3-01-3020C-20	66
3-01-3020C-22	66
3-01-3020C-23.5	66
3-01-3020C-25	66

Product Code Suspension Systems	Page no.
3-01-3020C-26.5	66
3-01-3020C-28	66
3-01-3020C-30	66
3-01-3020C-32	66
3-01-3020C-34	66
3-01-3020C-36	66
3-01-3020L-18	66
3-01-3020L-20	66
3-01-3020L-22	66
3-01-3020L-23.5	66
3-01-3020L-25	66
3-01-3020L-26.5	66
3-01-3020L-28	66
3-01-3020L-30	66
3-01-3020L-32	66
3-01-3020L-34	66
3-01-3020L-36	66
3-01-3030C-21	70
3-01-3030C-22	70
3-01-3030C-23.5	70
3-01-3030C-25	70
3-01-3030C-26.5	70
3-01-3030C-28	70
3-01-3030C-30	70
3-01-3030C-32	70
3-01-3030C-34	70
3-01-3030C-36	70
3-01-3030C-38	70
3-01-3030C-40	70
3-01-3030C-42	70
3-01-3030C-44	70
3-01-3030L-21	70
3-01-3030L-22	70
3-01-3030L-23.5	70
3-01-3030L-25	70
3-01-3030L-26.5	70
3-01-3030L-28	70
3-01-3030L-30	70
3-01-3030L-32	70
3-01-3030L-34	70
3-01-3030L-36	70
3-01-3030L-38	70
3-01-3030L-40	70
3-01-3030L-42	70
3-01-3030L-44	70
3-01-3070C-30	67
3-01-3070C-32	67
3-01-3070C-34	67
3-01-3070C-36	67

Product Code Suspension Systems	Page no.
3-01-3070C-38	67
3-01-3070C-40	67
3-01-3070C-45	67
3-01-3070L-30	67
3-01-3070L-32	67
3-01-3070L-34	67
3-01-3070L-36	67
3-01-3070L-38	67
3-01-3070L-40	67
3-01-3070L-45	67
3-01-3090L-30	68
3-01-3090L-32	68
3-01-3090L-34	68
3-01-3090L-36	68
3-01-3090L-38	68
3-01-3090L-40	68
3-01-3090L-45	68
3-01-3092L-30	69
3-01-3092L-32	69
3-01-3092L-34	69
3-01-3092L-36	69
3-01-3092L-38	69
3-01-3092L-40	69
3-01-3092L-45	69
3-01-3180M	58
3-01-3180-MDN	59
3-01-3181-MDN	59
3-01-3181MP	58
3-01-6210L-16	112
3-01-6210L-18	112
3-01-6210L-20	112
3-01-6210L-22	112
3-01-6210L-24	112
3-01-AKSS-L-S	75
3-01-AKSS-R-S	75
3-01-AKSS-L-M	75
3-01-AKSS-R-M	75
3-01-AKSS-L-L	75
3-01-AKSS-R-L	75
3-01-AKSS-L-XL	75
3-01-AKSS-R-XL	75
3-01-AKSS-L-XXL	75
3-01-AKSS-R-XXL	75
3-01-AKSS-L-XXXL	75
3-01-AKSS-R-XXXL	75
3-01-AKSS-L-XXXXL	75
3-01-AKSS-R-XXXXL	75
3-01-BSL-00	72
3-01-BSL-01	72

Index

Product Code Suspension Systems	Page no.
3-01-DSTCN	59
3-01-ECSS-S-BK	76
3-01-ECSS-M-BK	76
3-01-ECSS-L-BK	76
3-01-ECSS-S-TN	76
3-01-ECSS-M-TN	76
3-01-ECSS-L-TN	76
3-01-EF-S	73
3-01-EF-M	73
3-01-EF-L	73
3-01-EF-XL	73
3-01-EF-XXL	73
3-01-EZL	73
3-01-KB-S	76
3-01-KB-M	76
3-01-KB-L	76
3-01-LCL	72
3-01-LCL-PIN01	72
3-01-MAG30-18	61
3-01-MAG30-20	61
3-01-MAG30-22	61
3-01-MAG30-23.5	61
3-01-MAG30-25	61
3-01-MAG30-26.5	61
3-01-MAG30-28	61
3-01-MAG30-30	61
3-01-MAG30-32	61
3-01-MAG30-34	61
3-01-MAG30-36	61
3-01-MAG40-18	60
3-01-MAG40-20	60
3-01-MAG40-22	60
3-01-MAG40-23.5	60
3-01-MAG40-25	60
3-01-MAG40-26.5	60
3-01-MAG40-28	60
3-01-MAG40-30	60
3-01-MAG40-32	60
3-01-MAG40-34	60
3-01-MAG40-36	60
3-01-MAG50-30	63
3-01-MAG50-32	63
3-01-MAG50-34	63
3-01-MAG50-36	63
3-01-MAG50-38	63
3-01-MAG50-40	63
3-01-MAG50-45	63
3-01-MAG60-30	62
3-01-MAG60-32	62

Product Code Suspension Systems	Page no.
3-01-MAG60-34	62
3-01-MAG60-36	62
3-01-MAG60-38	62
3-01-MAG60-40	62
3-01-MAG60-45	62
3-01-SCL	71
3-01-SCL-P	71
3-01-SSL	71
3-01-SSL-P	71
3-01-TSL	71
3-01-TSL-PIN01	71
3-01-TSL-S	71
3-01-V1	75
3-01-V2	75
3-01-V4	74
3-01-V5	74
3-01-V6	74
3-01-V7	74
3-01-V8	73

Product Code Cosmetic Tools & Materials	Page no.
4-01-AKSTO	80
4-01-BKSTO	80
4-01-FA-L-36	78
4-01-FA-R-36	78
4-01-FA-L-40	78
4-01-FA-R-40	78
4-01-FA-L-44	78
4-01-FA-R-44	78
4-01-FB	79
4-01-FBE	80
4-01-FBP	79
4-01-FKD-L-36	78
4-01-FKD-R-36	78
4-01-FKD-L-40	78
4-01-FKD-R-40	78
4-01-FKD-L-44	78
4-01-FKD-R-44	78
4-01-FSD	80
4-02-CM	84
4-02-CMH	84
4-02-CSM-10	83
4-02-CSM-12	83
4-02-CSM-15	83
4-02-C-TB-3-10	88

Product Code Cosmetic Tools & Materials	Page no.
4-02-C-TB-3-50	88
4-02-C-TB-4-10	88
4-02-C-TB-4-50	88
4-02-C-TB-5-10	88
4-02-C-TB-5-50	88
4-02-C-TB-6-10	88
4-02-C-TB-6-50	88
4-02-C-TB-8-10	88
4-02-C-TB-8-50	88
4-02-C-TB-10-10	88
4-02-C-TB-10-50	88
4-02-ESM-10	83
4-02-ESM-12	83
4-02-ESM-15	83
4-02-GP-BL	94
4-02-GP-RE	94
4-02-LAD120	96
4-02-LOC243	96
4-02-LOC271	96
4-02-MAD	96
4-02-MP-2-ARMY	82
4-02-MP-2-BLWT	82
4-02-MP-2-MCOL	82
4-02-MP-2-PKBBK	82
4-02-MP-2-PUBK	82
4-02-MP-2-WTBK	82
4-02-MP-2-YLBK	82
4-02-MP-4-ARMY	82
4-02-MP-4-BLWT	82
4-02-MP-4-MCOL	82
4-02-MP-4-PKBBK	82
4-02-MP-4-PUBK	82
4-02-MP-4-WTBK	82
4-02-MP-4-YLBK	82
4-02-NSP-3-10	87
4-02-NSP-4-10	87
4-02-NSP-5-10	87
4-02-NSP-6-10	87
4-02-NSP-8-10	87
4-02-NSP-10-10	87
4-02-NSP-12-10	87
4-02-NSP-3-50	87
4-02-NSP-4-50	87
4-02-NSP-5-50	87
4-02-NSP-6-50	87
4-02-NSP-8-50	87
4-02-NSP-10-50	87
4-02-NSP-12-50	87
4-02-NSP-3K-1-30	88

Index

Product Code Cosmetic Tools & Materials	Page no.
4-02-NSP-3K-3-30	88
4-02-OAK	83
4-02-PARALEX-TB-3-10	89
4-02-PARALEX-TB-3-50	89
4-02-PARALEX-TB-4-10	89
4-02-PARALEX-TB-4-50	89
4-02-PARALEX-TB-5-10	89
4-02-PARALEX-TB-5-50	89
4-02-PARALEX-TB-6-10	89
4-02-PARALEX-TB-6-50	89
4-02-PARALEX-TB-8-10	89
4-02-PARALEX-TB-8-50	89
4-02-PARALEX-TB-10-10	89
4-02-PARALEX-TB-10-50	89
4-02-PBFL	100
4-02-PBHE	99
4-02-PBHR	100
4-02-PBRD	100
4-02-PB-75	86
4-02-PB-150	86
4-02-PBOLT-1	95
4-02-PBOLT-2	95
4-02-PBOLT-3	95
4-02-PBOLT-4	95
4-02-PC	95
4-02-PE-2	82
4-02-PE-3	82
4-02-PE-4	82
4-02-PE-5	82
4-02-PF-2	81
4-02-PF-3	81
4-02-PF-4	81
4-02-PF-5	81
4-02-PF-6	81
4-02-PIG-CA-100g	85
4-02-PIG-CA-1kg	85
4-02-PIG-BL-100g	85
4-02-PIG-BL-1kg	85
4-02-PIG-BK-100g	85
4-02-PIG-BK-1kg	85
4-02-PIG-BW-100g	85
4-02-PIG-BW-1kg	85
4-02-PIG-RE-100g	85
4-02-PIG-RE-1kg	85
4-02-PIG-WT-100g	85
4-02-PIG-WT-1kg	85
4-02-PIG-YL-100g	85
4-02-PIG-YL-1kg	85
4-02-PL-1	95

Product Code Cosmetic Tools & Materials	Page no.
4-02-PL-2	95
4-02-PP-2	82
4-02-PP-3	82
4-02-PP-4	82
4-02-PP-5	82
4-02-PUFA	85
4-02-PUFB	86
4-02-PVAB-XS	92
4-02-PVAB-S	92
4-02-PVAB-M	92
4-02-PVAB-L	92
4-02-PVAB-XL	92
4-02-PVA-E50	92
4-02-PVA-E100	92
4-02-PVA-P100	92
4-02-PZ-3	81
4-02-PZ-6	81
4-02-PZ-12	81
4-02-RHB001M	97
4-02-RHB002M	97
4-02-RHB003M	97
4-02-RHB004M	97
4-02-SD01	97
4-02-SD02I	97
4-02-SD02M	97
4-02-SD03I	97
4-02-SD03M	97
4-02-SL01-040	97
4-02-SL01-060	97
4-02-SL01-080	97
4-02-SL01-100	97
4-02-SL02-040	97
4-02-SL02-060	97
4-02-SL02-080	97
4-02-SL02-100	97
4-02-SL03-060	97
4-02-SL03-080	97
4-02-SL03-100	97
4-02-SP-A	93
4-02-SP-B	93
4-02-STO-COT-060	91
4-02-STO-COT-090	91
4-02-STO-COT-130	91
4-02-STO-COT-150	91
4-02-STO-COT-250	91
4-02-STO-COT-300	91
4-02-STO-FG-060	91
4-02-STO-FG-080	91
4-02-STO-FG-090	91

Product Code Cosmetic Tools & Materials	Page no.
4-02-STO-FG-100	91
4-02-STO-FG-120	91
4-02-STO-FG-130	91
4-02-STO-FG-150	91
4-02-STO-FG-180	91
4-02-STO-FG-200	91
4-02-STO-FG-250	91
4-02-STO-POL-060	91
4-02-STO-POL-080	91
4-02-STO-POL-090	91
4-02-STO-POL-100	91
4-02-STO-POL-120	91
4-02-STO-POL-130	91
4-02-STO-POL-150	91
4-02-STO-POL-180	91
4-02-STO-POL-200	91
4-02-STO-POL-240	91
4-02-STO-POL-250	91
4-02-UG-1	81
4-02-UG-2	81
4-02-ULTC-TB-3-10	90
4-02-ULTC-TB-3-50	90
4-02-ULTC-TB-4-10	90
4-02-ULTC-TB-4-50	90
4-02-ULTC-TB-5-10	90
4-02-ULTC-TB-5-50	90
4-02-ULTC-TB-6-10	90
4-02-ULTC-TB-6-50	90
4-02-ULTC-TB-8-10	90
4-02-ULTC-TB-8-50	90
4-02-ULTC-TB-10-10	90
4-02-ULTC-TB-10-50	90
4-02-ULTC-TP-1-30	90
4-02-ULTC-TP-3-30	90
4-02-ULTC-TP-3-100	90
4-02-WC-IM-L	98
4-02-WC-IM-M	98
4-02-WC-IM-S	98
4-02-WC-MT-L	98
4-02-WC-MT-M	98
4-02-WC-MT-S	98
4-02-WH-MT-40	99
4-02-WH-MT-45	99
4-02-WH-MT-50	99
4-02-WH-IM-40	99
4-02-WH-IM-45	99
4-02-WH-IM-50	99
4-02-WS-150	96
4-02-WS-160	96

Index

Product Code Orthotics & Rehabilitation	Page no.
5-01-AFO001-L-S	102
5-01-AFO001-R-S	102
5-01-AFO001-L-M	102
5-01-AFO001-R-M	102
5-01-AFO001-L-L	102
5-01-AFO001-R-L	102
5-01-AFO001-L-XL	102
5-01-AFO001-R-XL	102
5-01-AFO002-L-S	102
5-01-AFO002-R-S	102
5-01-AFO002-L-M	102
5-01-AFO002-R-M	102
5-01-AFO002-L-L	102
5-01-AFO002-R-L	102
5-01-AFO002-L-XL	102
5-01-AFO002-R-XL	102
5-01-COL001-2-S	107
5-01-COL001-2-M	107
5-01-COL001-2-L	107
5-01-COL001-2-XL	107
5-01-COL001-3-S	107
5-01-COL001-3-M	107
5-01-COL001-3-L	107
5-01-COL001-3-XL	107
5-01-COL001-4-S	107
5-01-COL001-4-M	107
5-01-COL001-4-L	107
5-01-COL001-4-XL	107
5-01-COL001-5-S	107
5-01-COL001-5-M	107
5-01-COL001-5-L	107
5-01-COL001-5-XL	107
5-01-DS100	104
5-01-DS200	105
5-01-FL-XS	109
5-01-FL-S	109
5-01-FL-M	109
5-01-FL-L	109
5-01-FL-XL	109
5-01-HCC-S	110
5-01-HCC-M	110
5-01-HCC-L	110
5-01-MAJ001-P	106
5-01-MAJ001-A	106
5-01-MAJ001-HD	106
5-01-MAJKIT-P	106
5-01-MAJKIT-A	106
5-01-MAJKIT-HD	106
5-01-OFFS-SS-16-16	108

Product Code Orthotics & Rehabilitation	Page no.
5-01-OFFS-SS-16-22	108
5-01-OFFS-SS-19-16	108
5-01-OFFS-SS-19-22	108
5-01-PFSS-S	104
5-01-PFSS-M	104
5-01-PFSS-L	104
5-01-QL-S	110
5-01-QL-M	110
5-01-QL-L	110
5-01-RB01	105
5-01-RFD100	103
5-01-RFS100	103
5-01-RFS100DM	103
5-01-RLOC-AL	108
5-01-RLOC-SS	108
5-01-RTB-BK	104
5-01-RTB-WT	104
5-01-SB01-S	106
5-01-SB01-M	106
5-01-SB01-L	106
5-01-SB01-XL	106
5-01-SLOC-AL	108
5-01-SLOC-SS	108
5-01-TS-S	110
5-01-TS-M	110
5-01-TS-L	110

Product Code Upperlimbs modular prosthesis	Page no.
6-01-EJ1-CA	112
6-01-EJ1-DKBW	112
6-01-EJ2N-L	113
6-01-EJ2N-R	113
6-01-EJ3N	113
6-01-SJ1N-L	113
6-01-SJ1N-R	113
6-02-MH1-IM-L-M	114
6-02-MH1-IM-R-M	114
6-02-MH1-IM-L-L	114
6-02-MH1-IM-R-L	114
6-02-MH1-IM-L-XL	114
6-02-MH1-IM-R-XL	114
6-02-MH1-MT-L-M	114
6-02-MH1-MT-R-M	114
6-02-MH1-MT-L-L	114
6-02-MH1-MT-R-L	114
6-02-MH1-MT-L-XL	114
6-02-MH1-MT-R-XL	114
6-02-PVCIH-L-M	114
6-02-PVCIH-R-M	114
6-02-PVCIH-L-L	114
6-02-PVCIH-R-L	114
6-02-PVCIH-L-XL	114
6-02-PVCIH-R-XL	114

Pediatric



SACH foot (pediatric, no toe)

0-01-FTT-NT

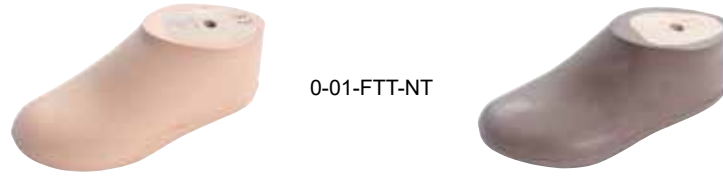

Product Code	Side	Foot Length	Heel Height	Max. Load	SACH ankle bolt	Color
0-01-FTT-NT-L-12	Left	12cm	10mm	35kg	M8	Caucasian
0-01-FTT-NT-R-12	Right	12cm	10mm	35kg	M8	Caucasian
0-01-FTT-NT-L-13	Left	13cm	10mm	35kg	M8	Caucasian
0-01-FTT-NT-R-13	Right	13cm	10mm	35kg	M8	Caucasian
0-01-FTT-NT-L-14	Left	14cm	10mm	45kg	M8	Caucasian
0-01-FTT-NT-R-14	Right	14cm	10mm	45kg	M8	Caucasian
0-01-FTT-NT-L-15	Left	15cm	10mm	50kg	M8	Caucasian
0-01-FTT-NT-R-15	Right	15cm	10mm	50kg	M8	Caucasian
0-01-FTT-NT-L-16	Left	16cm	10mm	55kg	M8	Caucasian
0-01-FTT-NT-R-16	Right	16cm	10mm	55kg	M8	Caucasian
0-01-FTT-NT-L-17	Left	17cm	10mm	60kg	M8	Caucasian
0-01-FTT-NT-R-17	Right	17cm	10mm	60kg	M8	Caucasian
0-01-FTT-NT-L-12B	Left	12cm	10mm	35kg	M8	Brown
0-01-FTT-NT-R-12B	Right	12cm	10mm	35kg	M8	Brown
0-01-FTT-NT-L-13B	Left	13cm	10mm	35kg	M8	Brown
0-01-FTT-NT-R-13B	Right	13cm	10mm	35kg	M8	Brown
0-01-FTT-NT-L-14B	Left	14cm	10mm	45kg	M8	Brown
0-01-FTT-NT-R-14B	Right	14cm	10mm	45kg	M8	Brown
0-01-FTT-NT-L-15B	Left	15cm	10mm	50kg	M8	Brown
0-01-FTT-NT-R-15B	Right	15cm	10mm	50kg	M8	Brown
0-01-FTT-NT-L-16B	Left	16cm	10mm	55kg	M8	Brown
0-01-FTT-NT-R-16B	Right	16cm	10mm	55kg	M8	Brown
0-01-FTT-NT-L-17B	Left	17cm	10mm	60kg	M8	Brown
0-01-FTT-NT-R-17B	Right	17cm	10mm	60kg	M8	Brown

SACH foot (pediatric, open toe)

0-01-FTT



Product Code	Side	Foot Length	Heel Height	Max. Load	SACH ankle bolt	Color
0-01-FTT-L-15	Left	15cm	10mm	50kg	M8	Caucasian
0-01-FTT-R-15	Right	15cm	10mm	50kg	M8	Caucasian
0-01-FTT-L-16	Left	16cm	10mm	55kg	M8	Caucasian
0-01-FTT-R-16	Right	16cm	10mm	55kg	M8	Caucasian
0-01-FTT-L-17	Left	17cm	10mm	60kg	M8	Caucasian
0-01-FTT-R-17	Right	17cm	10mm	60kg	M8	Caucasian
0-01-FTT-L-18	Left	18cm	10mm	70kg	M8	Caucasian
0-01-FTT-R-18	Right	18cm	10mm	70kg	M8	Caucasian
0-01-FTT-L-19	Left	19cm	10mm	80kg	M8	Caucasian
0-01-FTT-R-19	Right	19cm	10mm	80kg	M8	Caucasian
0-01-FTT-L-15B	Left	15cm	10mm	50kg	M8	Brown
0-01-FTT-R-15B	Right	15cm	10mm	50kg	M8	Brown
0-01-FTT-L-16B	Left	16cm	10mm	55kg	M8	Brown
0-01-FTT-R-16B	Right	16cm	10mm	55kg	M8	Brown
0-01-FTT-L-17B	Left	17cm	10mm	60kg	M8	Brown
0-01-FTT-R-17B	Right	17cm	10mm	60kg	M8	Brown
0-01-FTT-L-18B	Left	18cm	10mm	70kg	M8	Brown
0-01-FTT-R-18B	Right	18cm	10mm	70kg	M8	Brown
0-01-FTT-L-19B	Left	19cm	10mm	80kg	M8	Brown
0-01-FTT-R-19B	Right	19cm	10mm	80kg	M8	Brown

Male socket adaptor (pediatric)

0-02-A1SC/ 0-02-A1AC



0-02-A1SC



0-02-A1AC

Product Code	Weight	Material	Max. Load
0-02-A1SC	55g	SS	45kg
0-02-A1AC	33g	AL	45kg

Pediatric

Feet & Adaptors

Female socket adaptor (pediatric)

0-02-A5AC



0-02-A5AC

Product Code	Weight	Material	Max. Load
0-02-A5AC	42g	AL	45kg

Knee joints & Hip Joints

Suspension Systems

Female tube adaptor (pediatric)

0-02-A6AC



0-02-A6AC

Product Code	Weight	Material	Max. Load
0-02-A6AC	36g	AL	45kg

Cosmetic, Tools & Materials

Orthotics & Rehabilitation

Angled tube adaptor (pediatric)

0-02-A10AC



0-02-A10AC

Product Code	Weight	Material	Max. Load
0-02-A10AC	50g	AL	45kg

Upperlimbs Modular Prosthesis

FAQ & Warranty

Attachment block (pediatric)

0-02-A22C



0-02-A22C

Product Code	Weight	Material	Max. Load
0-02-A22C	98g	Polycarbonate & Fiber Glass	45kg

SACH ankle adaptor (pediatric)

0-02-2N1SC/ 0-02-2N1TC



0-02-2N1SC / 0-02-2N1TC

Product Code	Weight	Material	Max. Load
0-02-2N1TC	39g	TI	45kg
0-02-2N1SC	62g	SS	45kg

Tube (pediatric)

0-02-BC150/ 0-02-BC300



0-02-BC150



0-02-BC300

Product Code	Length	Diameter	Weight	Material	Max. Load
0-02-BC150	150mm	Ø22mm	55g	AL	45kg
0-02-BC300	300mm	Ø22mm	125g	AL	45kg

Single axis knee joint (pediatric)

0-00-4S30C



0-00-4S30C

0-00-4S30C

Single axis knee joint (pediatric)

- Lightweight aluminum single axis
- Pediatric knee joint with proximal adjustment pyramid and distal tube clamp
- Proximal connection: adjustment pyramid
- Distal connection: tube clamp Ø 22mm

Product Code	Weight	Material	Max. Load	Mobility Level
0-00-4S30C	160g	AL	45kg	I

Pediatric 4 Bar knee joint (AK/KD)

0-00-4S41C



0-00-4S41C

0-00-4S41C Pediatric 4 Bar knee joint (AK/KD)

- The knee joint is light weight 4 bar knee joint for pediatric
- Standard adaptor: Pyramid (AK)
- Optional adaptor: 3-prong adaptor (for KD)
- If you like to order maintenance part, please feel free to contact us



0-00-4S41C



0-00-4S41C=LA

Product Code	Weight	Material	Max. Load	Mobility Level
0-00-4S41C	320g	AL	55kg	II III
0-00-4S41C=LA	320g	AL	55kg	II III

Accessories



0-00-4S41C-01

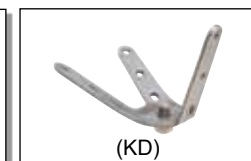

0-00-4S41C=LA-01

Product Code	Material	Description
0-00-4S41C-01	SS	Pyramid adaptor(AK)
0-00-4S41C=LA-01	SS	3-prong adaptor (KD)

Pediatric 4 Bar knee joint with manual lock (AK/KD)

0-00-4S40C



0-00-4S40C

0-00-4S40C Pediatric 4 Bar knee joint with manual lock (AK/KD)

- The knee joint is light weight manual locking knee joint for pediatric with very low functional level
- Standard adaptor: Pyramid (AK)
- Optional adaptor: 3-prong adaptor (for KD)
- If you like to order maintenance part, please feel free to contact us



0-00-4S40C



0-00-4S40C=LA

Product Code	Weight	Material	Max. Load	Mobility Level
0-00-4S40C	387g	AL	55kg	II III
0-00-4S40C=LA	387g	AL	55kg	II III

Accessories

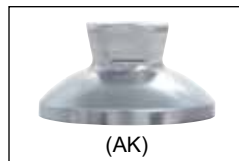

(AK)

0-00-4S40C-01

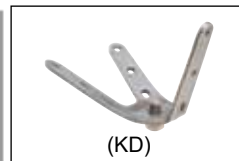

(KD)

0-00-4S40C=LA-01



Lock set

0-00-4S40C-02

Product Code	Material	Description
0-00-4S40C-01	SS	Pyramid adaptor(AK)
0-00-4S40C=LA-01	SS	3-prong adaptor (KD)
0-00-4S40C-02	-	Lock set

Pediatric aluminium polycentric mechanical hip joint

0-00-H1C



0-00-H1C

0-00-H1C Pediatric aluminium polycentric mechanical hip joint

- lightweight design

Product Code	Weight	Material	Max. Load
0-00-H1C	550g	AL	55kg



0-00-H1C-01

Product Code	Description
0-00-H1C-01	Anchor plate

Above knee foam cover (pediatric)

0-01-FAC



0-01-FAC

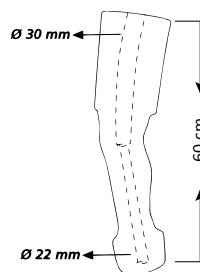

0-01-FAC Above knee foam cover (pediatric)

- Durable foam
- One size
- 30° knee flexion
- Preshaped
- Center Hole
- Skin Color



Product Code	Calf Circum.	Hole diameter	Length
0-01-FAC	30-22cm	22-30mm	60cm

Foam covers are available in vacuum pack

Below knee foam cover (pediatric)

0-01-FBC



0-01-FBC

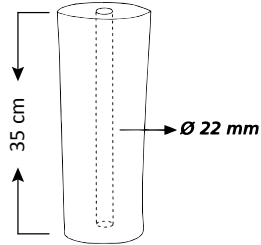

0-01-FBC Below knee foam cover (pediatric)

- Durable foam
- One size
- Unshaped
- Center Hole
- Skin Color

Product Code	Hole diameter	Length
0-01-FBC	22mm	35cm

Foam covers are available in vacuum pack

Ring lock system - Straight (pediatric)

0-01-RLOCC-AL



0-01-RLOCC-AL

Product Code	Length	Width	Thickness	Weight	Description
0-01-RLOCC-AL	740mm	12mm	5mm	400g	Aluminum upright bar

Ring lock system - Straight (pediatric)

0-01-RLOCC-SS



0-01-RLOCC-SS

Product Code	Length	Width	Thickness	Weight	Description
0-01-RLOCC-SS	460mm	12mm	3mm	350g	Stainless steel upright bar

Ridge flex ankle joint (pediatric)

0-01-RF

0-01-RF Ridge flex ankle joint (pediatric)



- The RidgeFlex Ankle Joint represents optimal balance between flexibility and rigidity due to the utilization of a proprietary material called Prepalon
- Prepalon is a continuous fiber and elastomer blend technology (CFET)
- The use of flexible elastomer provides optimum tear strength, preventing fatigue failure
- Continuous fiber blended within the elastomer provides structure and rigidity, preventing the joint from stretching
- This technology eliminates the need for strings which do not provide any support in rotation or A-P movement
- Material technology allows for bold concepts which led to the creation of the tendon design. The tendon design offers a smooth movement while providing proper support in the sagittal plane and rotational control
- Combination of flexible elastomer and continuous fiber blend for rigidity allows for optimum balance of smooth movement and rigid support
- No need to compromise the tear strength by using a higher density elastomer for more support. Higher density in elastomer means weaker tear strength, thus compromising the structural integrity of the joint

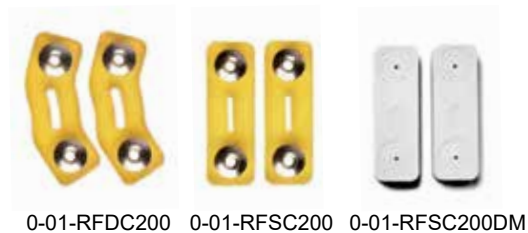

0-01-RFDC200 0-01-RFSC200 0-01-RFSC200DM

Product Code	Description	Length	Width
0-01-RFDC200	Pediatric Dorsiflexion Assist	36mm	11mm
0-01-RFSC200	Pediatric Standard	34mm	11mm
0-01-RFSC200DM	Pediatric Dummy – (Dorsiflexion Assist & Standard)		

Pediatric

Feet & Adaptors

Knee joints & Hip Joints

Suspension Systems

Cosmetic, Tools & Materials

Orthotics & Rehabilitation

Upperlimbs Modular Prosthesis

FAQ & Warranty

Pediatric

Feet &
Adaptors

Knee joints &
Hip Joints

Suspension
Systems

Cosmetic, Tools
& Materials

Orthotics &
Rehabilitation

Upperlimbs
Modular Prosthesis

FAQ & Warranty

Feet and Adaptors



Regal Feet and Adaptors

Aluminium BK kit

Pediatric

Feet & Adaptors

Knee joints & Hip Joints

Suspension Systems

Cosmetic, Tools & Materials

Orthotics & Rehabilitation

Upperlimbs Modular Prosthesis

FAQ & Warranty



1-02-A1A
Male socket adaptor
page 31



1-02-A2A
Male socket adaptor
page 33



1-02-A6A
Female tube adaptor
page 35



1-02-BO250
Tube with female pyramid adaptor
page 30



1-02-2N1A
SACH ankle adaptor
page 28



1-01-FTT
SACH foot (open toe)
page 23

SACH foot (pediatric, no toe)

0-01-FTT-NT



0-01-FTT-NT

Product Code	Side	Foot Length	Heel Height	Max. Load	SACH ankle bolt	Color
0-01-FTT-NT-L-12	Left	12cm	10mm	35kg	M8	Caucasian
0-01-FTT-NT-R-12	Right	12cm	10mm	35kg	M8	Caucasian
0-01-FTT-NT-L-13	Left	13cm	10mm	35kg	M8	Caucasian
0-01-FTT-NT-R-13	Right	13cm	10mm	35kg	M8	Caucasian
0-01-FTT-NT-L-14	Left	14cm	10mm	45kg	M8	Caucasian
0-01-FTT-NT-R-14	Right	14cm	10mm	45kg	M8	Caucasian
0-01-FTT-NT-L-15	Left	15cm	10mm	50kg	M8	Caucasian
0-01-FTT-NT-R-15	Right	15cm	10mm	50kg	M8	Caucasian
0-01-FTT-NT-L-16	Left	16cm	10mm	55kg	M8	Caucasian
0-01-FTT-NT-R-16	Right	16cm	10mm	55kg	M8	Caucasian
0-01-FTT-NT-L-17	Left	17cm	10mm	60kg	M8	Caucasian
0-01-FTT-NT-R-17	Right	17cm	10mm	60kg	M8	Caucasian
0-01-FTT-NT-L-12B	Left	12cm	10mm	35kg	M8	Brown
0-01-FTT-NT-R-12B	Right	12cm	10mm	35kg	M8	Brown
0-01-FTT-NT-L-13B	Left	13cm	10mm	35kg	M8	Brown
0-01-FTT-NT-R-13B	Right	13cm	10mm	35kg	M8	Brown
0-01-FTT-NT-L-14B	Left	14cm	10mm	45kg	M8	Brown
0-01-FTT-NT-R-14B	Right	14cm	10mm	45kg	M8	Brown
0-01-FTT-NT-L-15B	Left	15cm	10mm	50kg	M8	Brown
0-01-FTT-NT-R-15B	Right	15cm	10mm	50kg	M8	Brown
0-01-FTT-NT-L-16B	Left	16cm	10mm	55kg	M8	Brown
0-01-FTT-NT-R-16B	Right	16cm	10mm	55kg	M8	Brown
0-01-FTT-NT-L-17B	Left	17cm	10mm	60kg	M8	Brown
0-01-FTT-NT-R-17B	Right	17cm	10mm	60kg	M8	Brown

Pediatric

Feet & Adaptors

Knee joints & Hip Joints

Suspension Systems

Cosmetic, Tools & Materials

Orthotics & Rehabilitation

Upperlimbs Modular Prosthesis

FAQ & Warranty

Regal Feet and Adaptors

SACH foot (pediatric, open toe)

0-01-FTT



0-01-FTT

Product Code	Side	Foot Length	Heel Height	Max. Load	SACH ankle bolt	Color
0-01-FTT-L-15	Left	15cm	10mm	50kg	M8	Caucasian
0-01-FTT-R-15	Right	15cm	10mm	50kg	M8	Caucasian
0-01-FTT-L-16	Left	16cm	10mm	55kg	M8	Caucasian
0-01-FTT-R-16	Right	16cm	10mm	55kg	M8	Caucasian
0-01-FTT-L-17	Left	17cm	10mm	60kg	M8	Caucasian
0-01-FTT-R-17	Right	17cm	10mm	60kg	M8	Caucasian
0-01-FTT-L-18	Left	18cm	10mm	70kg	M8	Caucasian
0-01-FTT-R-18	Right	18cm	10mm	70kg	M8	Caucasian
0-01-FTT-L-19	Left	19cm	10mm	80kg	M8	Caucasian
0-01-FTT-R-19	Right	19cm	10mm	80kg	M8	Caucasian
0-01-FTT-L-15B	Left	15cm	10mm	50kg	M8	Brown
0-01-FTT-R-15B	Right	15cm	10mm	50kg	M8	Brown
0-01-FTT-L-16B	Left	16cm	10mm	55kg	M8	Brown
0-01-FTT-R-16B	Right	16cm	10mm	55kg	M8	Brown
0-01-FTT-L-17B	Left	17cm	10mm	60kg	M8	Brown
0-01-FTT-R-17B	Right	17cm	10mm	60kg	M8	Brown
0-01-FTT-L-18B	Left	18cm	10mm	70kg	M8	Brown
0-01-FTT-R-18B	Right	18cm	10mm	70kg	M8	Brown
0-01-FTT-L-19B	Left	19cm	10mm	80kg	M8	Brown
0-01-FTT-R-19B	Right	19cm	10mm	80kg	M8	Brown

SACH ankle adaptor (pediatric)
0-02-2N1SC or 0-02-2N1TC (see page 25 of this catalogue)

Pediatric

Feet & Adaptors

Knee joints & Hip Joints

Suspension Systems

Cosmetic, Tools & Materials

Orthotics & Rehabilitation

Upperlimbs Modular Prosthesis

FAQ & Warranty

SACH foot (adult, open toe)

1-01-FTT



Product Code	Side	Foot Length	Heel Height	Max. Load	SACH ankle bolt	Color
1-01-FTT-L-20	Left	20cm	10mm	100kg	M10	Caucasian
1-01-FTT-R-20	Right	20cm	10mm	100kg	M10	Caucasian
1-01-FTT-L-21	Left	21cm	10mm	100kg	M10	Caucasian
1-01-FTT-R-21	Right	21cm	10mm	100kg	M10	Caucasian
1-01-FTT-L-22	Left	22cm	10mm	100kg	M10	Caucasian
1-01-FTT-R-22	Right	22cm	10mm	100kg	M10	Caucasian
1-01-FTT-L-23	Left	23cm	10mm	100kg	M10	Caucasian
1-01-FTT-R-23	Right	23cm	10mm	100kg	M10	Caucasian
1-01-FTT-L-24	Left	24cm	10mm	100kg	M10	Caucasian
1-01-FTT-R-24	Right	24cm	10mm	100kg	M10	Caucasian
1-01-FTT-L-25	Left	25cm	10mm	100kg	M10	Caucasian
1-01-FTT-R-25	Right	25cm	10mm	100kg	M10	Caucasian
1-01-FTT-L-26	Left	26cm	10mm	100kg	M10	Caucasian
1-01-FTT-R-26	Right	26cm	10mm	100kg	M10	Caucasian
1-01-FTT-L-27	Left	27cm	10mm	100kg	M10	Caucasian
1-01-FTT-R-27	Right	27cm	10mm	100kg	M10	Caucasian
1-01-FTT-L-28	Left	28cm	10mm	100kg	M10	Caucasian
1-01-FTT-R-28	Right	28cm	10mm	100kg	M10	Caucasian
1-01-FTT-L-29	Left	29cm	10mm	100kg	M10	Caucasian
1-01-FTT-R-29	Right	29cm	10mm	100kg	M10	Caucasian
1-01-FTT-L-30	Left	30cm	10mm	100kg	M10	Caucasian
1-01-FTT-R-30	Right	30cm	10mm	100kg	M10	Caucasian
1-01-FTT-L-20B	Left	20cm	10mm	100kg	M10	Brown
1-01-FTT-R-20B	Right	20cm	10mm	100kg	M10	Brown
1-01-FTT-L-21B	Left	21cm	10mm	100kg	M10	Brown
1-01-FTT-R-21B	Right	21cm	10mm	100kg	M10	Brown
1-01-FTT-L-22B	Left	22cm	10mm	100kg	M10	Brown
1-01-FTT-R-22B	Right	22cm	10mm	100kg	M10	Brown
1-01-FTT-L-23B	Left	23cm	10mm	100kg	M10	Brown
1-01-FTT-R-23B	Right	23cm	10mm	100kg	M10	Brown
1-01-FTT-L-24B	Left	24cm	10mm	100kg	M10	Brown
1-01-FTT-R-24B	Right	24cm	10mm	100kg	M10	Brown
1-01-FTT-L-25B	Left	25cm	10mm	100kg	M10	Brown
1-01-FTT-R-25B	Right	25cm	10mm	100kg	M10	Brown
1-01-FTT-L-26B	Left	26cm	10mm	100kg	M10	Brown
1-01-FTT-R-26B	Right	26cm	10mm	100kg	M10	Brown
1-01-FTT-L-27B	Left	27cm	10mm	100kg	M10	Brown
1-01-FTT-R-27B	Right	27cm	10mm	100kg	M10	Brown
1-01-FTT-L-28B	Left	28cm	10mm	100kg	M10	Brown
1-01-FTT-R-28B	Right	28cm	10mm	100kg	M10	Brown
1-01-FTT-L-29B	Left	29cm	10mm	100kg	M10	Brown
1-01-FTT-R-29B	Right	29cm	10mm	100kg	M10	Brown
1-01-FTT-L-30B	Left	30cm	10mm	100kg	M10	Brown
1-01-FTT-R-30B	Right	30cm	10mm	100kg	M10	Brown



1-01-FTT-01 (connection plate for FTT)
(one size, suitable for 1-01-FTT, size 20cm-30cm)

Product Code

1-01-FTT-01

Regal Feet and Adaptors

Single axis foot (adult)

1-01-FT



1-01-FT



Product Code	Side	Foot Length	Heel Height	Max. Load	Color
1-01-FT-L-21	Left	21cm	10mm	100kg	Caucasian
1-01-FT-R-21	Right	21cm	10mm	100kg	Caucasian
1-01-FT-L-22	Left	22cm	10mm	100kg	Caucasian
1-01-FT-R-22	Right	22cm	10mm	100kg	Caucasian
1-01-FT-L-23	Left	23cm	10mm	100kg	Caucasian
1-01-FT-R-23	Right	23cm	10mm	100kg	Caucasian
1-01-FT-L-24	Left	24cm	10mm	100kg	Caucasian
1-01-FT-R-24	Right	24cm	10mm	100kg	Caucasian
1-01-FT-L-25	Left	25cm	10mm	100kg	Caucasian
1-01-FT-R-25	Right	25cm	10mm	100kg	Caucasian
1-01-FT-L-26	Left	26cm	10mm	100kg	Caucasian
1-01-FT-R-26	Right	26cm	10mm	100kg	Caucasian
1-01-FT-L-27	Left	27cm	10mm	100kg	Caucasian
1-01-FT-R-27	Right	27cm	10mm	100kg	Caucasian
1-01-FT-L-28	Left	28cm	10mm	100kg	Caucasian
1-01-FT-R-28	Right	28cm	10mm	100kg	Caucasian
1-01-FT-L-29	Left	29cm	10mm	100kg	Caucasian
1-01-FT-R-29	Right	29cm	10mm	100kg	Caucasian
1-01-FT-L-30	Left	30cm	10mm	100kg	Caucasian
1-01-FT-R-30	Right	30cm	10mm	100kg	Caucasian
1-01-FT-L-21B	Left	21cm	10mm	100kg	Brown
1-01-FT-R-21B	Right	21cm	10mm	100kg	Brown
1-01-FT-L-22B	Left	22cm	10mm	100kg	Brown
1-01-FT-R-22B	Right	22cm	10mm	100kg	Brown
1-01-FT-L-23B	Left	23cm	10mm	100kg	Brown
1-01-FT-R-23B	Right	23cm	10mm	100kg	Brown
1-01-FT-L-24B	Left	24cm	10mm	100kg	Brown
1-01-FT-R-24B	Right	24cm	10mm	100kg	Brown
1-01-FT-L-25B	Left	25cm	10mm	100kg	Brown
1-01-FT-R-25B	Right	25cm	10mm	100kg	Brown
1-01-FT-L-26B	Left	26cm	10mm	100kg	Brown
1-01-FT-R-26B	Right	26cm	10mm	100kg	Brown
1-01-FT-L-27B	Left	27cm	10mm	100kg	Brown
1-01-FT-R-27B	Right	27cm	10mm	100kg	Brown
1-01-FT-L-28B	Left	28cm	10mm	100kg	Brown
1-01-FT-R-28B	Right	28cm	10mm	100kg	Brown
1-01-FT-L-29B	Left	29cm	10mm	100kg	Brown
1-01-FT-R-29B	Right	29cm	10mm	100kg	Brown
1-01-FT-L-30B	Left	30cm	10mm	100kg	Brown
1-01-FT-R-30B	Right	30cm	10mm	100kg	Brown



1-01-FT-01

connection cap for Regal FT

Product Code	Size
1-01-FT-01-21	21cm
1-01-FT-01-22	22cm
1-01-FT-01-23	23cm
1-01-FT-01-24	24cm
1-01-FT-01-25	25cm
1-01-FT-01-26	26cm
1-01-FT-01-27	27cm
1-01-FT-01-28	28cm

Pediatric

Feet & Adaptors

Knee joints & Hip Joints

Suspension Systems

Cosmetic, Tools & Materials

Orthotics & Rehabilitation

Upperlimbs Modular Prosthesis

FAQ & Warranty

DYNA foot

1-01-DYNA



1-01-DYNA DYNA foot with fiber glass keel

- Special fiber composite and smart design to provide good energy restoring function
- An economy version compare to carbon fiber composite



1-01-DYNA



Product Code	Side	Foot length	Heel Height	Max. Load	Color
1-01-DYNA-L-22	Left	22cm	10mm	90kg	Caucasian
1-01-DYNA-R-22	Right	22cm	10mm	90kg	Caucasian
1-01-DYNA-L-23	Left	23cm	10mm	90kg	Caucasian
1-01-DYNA-R-23	Right	23cm	10mm	90kg	Caucasian
1-01-DYNA-L-24	Left	24cm	10mm	90kg	Caucasian
1-01-DYNA-R-24	Right	24cm	10mm	90kg	Caucasian
1-01-DYNA-L-25	Left	25cm	10mm	90kg	Caucasian
1-01-DYNA-R-25	Right	25cm	10mm	90kg	Caucasian
1-01-DYNA-L-26	Left	26cm	10mm	90kg	Caucasian
1-01-DYNA-R-26	Right	26cm	10mm	90kg	Caucasian
1-01-DYNA-L-27	Left	27cm	10mm	100kg	Caucasian
1-01-DYNA-R-27	Right	27cm	10mm	100kg	Caucasian
1-01-DYNA-L-28	Left	28cm	10mm	100kg	Caucasian
1-01-DYNA-R-28	Right	28cm	10mm	100kg	Caucasian
1-01-DYNA-L-29	Left	29cm	10mm	100kg	Caucasian
1-01-DYNA-R-29	Right	29cm	10mm	100kg	Caucasian
1-01-DYNA-L-22B	Left	22cm	10mm	90kg	Brown
1-01-DYNA-R-22B	Right	22cm	10mm	90kg	Brown
1-01-DYNA-L-23B	Left	23cm	10mm	90kg	Brown
1-01-DYNA-R-23B	Right	23cm	10mm	90kg	Brown
1-01-DYNA-L-24B	Left	24cm	10mm	90kg	Brown
1-01-DYNA-R-24B	Right	24cm	10mm	90kg	Brown
1-01-DYNA-L-25B	Left	25cm	10mm	90kg	Brown
1-01-DYNA-R-25B	Right	25cm	10mm	90kg	Brown
1-01-DYNA-L-26B	Left	26cm	10mm	90kg	Brown
1-01-DYNA-R-26B	Right	26cm	10mm	90kg	Brown
1-01-DYNA-L-27B	Left	27cm	10mm	100kg	Brown
1-01-DYNA-R-27B	Right	27cm	10mm	100kg	Brown
1-01-DYNA-L-28B	Left	28cm	10mm	100kg	Brown
1-01-DYNA-R-28B	Right	28cm	10mm	100kg	Brown
1-01-DYNA-L-29B	Left	29cm	10mm	100kg	Brown
1-01-DYNA-R-29B	Right	29cm	10mm	100kg	Brown



1-01-DYNA-01

Product Code	Description
1-01-DYNA-01	Fixed adaptor for DYNA foot

Regal Feet and Adaptors

ToeFlex

1-01-TF

Pediatric



1-01-TF

New! 1-01-TF ToeFlex

- The innovative design of the ToeFlex promotes a functional and dynamic motion through the split carbon heel, multi-axial ankle, and independent split toe features, which provides additional leverage for improved balance and smoothness during gait
- Connector: Male pyramid

Feet & Adaptors

Knee joints & Hip Joints

Suspension Systems

Cosmetic, Tools & Materials

Orthotics & Rehabilitation

Upperlimbs Modular Prosthesis

FAQ & Warranty

Product Code	Size	Build Height	Weight	Max. Load
1-01-TF-23-24	23-24	2.58"	487.8g	125kg
1-01-TF-25-26	25-26	2.65"	528.3g	125kg
1-01-TF-27-28	27-28	2.77"	580.6g	125kg



1-01-FS
Foot Shell for ToeFlex

Product Code	Side	Size	Color
1-01-FS-L-23	Left	23cm	Beige
1-01-FS-R-23	Right	23cm	Beige
1-01-FS-L-24	Left	24cm	Beige
1-01-FS-R-24	Right	24cm	Beige
1-01-FS-L-25	Left	25cm	Beige
1-01-FS-R-25	Right	25cm	Beige
1-01-FS-L-26	Left	26cm	Beige
1-01-FS-R-26	Right	26cm	Beige
1-01-FS-L-27	Left	27cm	Beige
1-01-FS-R-27	Right	27cm	Beige
1-01-FS-L-28	Left	28cm	Beige
1-01-FS-R-28	Right	28cm	Beige
1-01-FS-L-23B	Left	23cm	Brown
1-01-FS-R-23B	Right	23cm	Brown
1-01-FS-L-24B	Left	24cm	Brown
1-01-FS-R-24B	Right	24cm	Brown
1-01-FS-L-25B	Left	25cm	Brown
1-01-FS-R-25B	Right	25cm	Brown
1-01-FS-L-26B	Left	26cm	Brown
1-01-FS-R-26B	Right	26cm	Brown
1-01-FS-L-27B	Left	27cm	Brown
1-01-FS-R-27B	Right	27cm	Brown
1-01-FS-L-28B	Left	28cm	Brown
1-01-FS-R-28B	Right	28cm	Brown



1-01-SS
Spectra sock

Product Code	Size
1-01-SS	23-25
1-01-SSL	26-28 (Large)



1-01-FSTOOL
Foot Shell Removal Tool

Product Code
1-01-FSTOOL

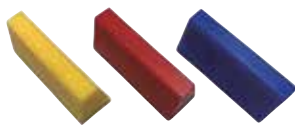

1-01-BUMP
Bumper

Product Code	Hardness (Shore A)	Body Weight	Color
1-01-BUMP-YL	30	50-70kg	Yellow
1-01-BUMP-RE	40	70-90kg	Red
1-01-BUMP-BL	50	90-130kg	Blue

Male socket adaptor (pediatric)

0-02-A1SC/ 0-02-A1AC



0-02-A1SC



0-02-A1AC

Product Code	Weight	Material	Max. Load
0-02-A1SC	55g	SS	45kg
0-02-A1AC	33g	AL	45kg

Female socket adaptor (pediatric)

0-02-A5AC



0-02-A5AC

Product Code	Weight	Material	Max. Load
0-02-A5AC	42g	AL	45kg

Female tube adaptor (pediatric)

0-02-A6AC



0-02-A6AC

Product Code	Weight	Material	Max. Load
0-02-A6AC	36g	AL	45kg

Angled tube adaptor (pediatric)

0-02-A10AC



0-02-A10AC

Product Code	Weight	Material	Max. Load
0-02-A10AC	50g	AL	45kg

Pediatric

Feet & Adaptors

Knee joints & Hip Joints

Suspension Systems

Cosmetic, Tools & Materials

Orthotics & Rehabilitation

Upperlimbs Modular Prosthesis

FAQ & Warranty

Regal Feet and Adaptors

Attachment block (pediatric)

0-02-A22C



0-02-A22C

Product Code	Weight	Material	Max. Load
0-02-A22C	98g	-	45kg

SACH ankle adaptor (pediatric)

0-02-2N1SC/ 0-02-2N1TC



0-02-2N1SC / 0-02-2N1TC

Product Code	Weight	Material	Max. Load
0-02-2N1TC	39g	TI	45kg
0-02-2N1SC	62g	SS	45kg

SACH ankle adaptor

1-02-2N1T/ 1-02-2N1S/ 1-02-2N1A



1-02-2N1T

1-02-2N1S

1-02-2N1A

Product Code	Weight	Material	Max. Load
1-02-2N1T	92g	TI	125kg
1-02-2N1S	135g	SS	125kg
1-02-2N1A	94g	AL	100kg

Pediatric

Feet & Adaptors

Knee joints & Hip Joints

Suspension Systems

Cosmetic, Tools & Materials

Orthotics & Rehabilitation

Upperlimbs Modular Prosthesis

FAQ & Warranty

Female tube adaptor

1-02-A6T-WRESIST



1-02-A6T-WRESIST

New!

1-02-A6T-WRESIST Female tube adaptor

- Water resistant components
- Titanium material
- With stainless steel corrosion resistant screw
- With four water channels to speed up water drainage
- Suitable for use when possible salt or chlorinated water contact, but not for full submersion

Product Code	Weight	Material	Max.Load
1-02-A6T-WRESIST	63g	TI	125kg

Tube with female pyramid adaptor (BK)

1-02-T2A1T-210-WRESIST



1-02-T2A1T-210-WRESIST



New!

1-02-T2A1T-210-WRESIST Tube with female pyramid adaptor (BK)

- Water resistant components
- Titanium/ Aluminium material
- With stainless steel corrosion resistant screw
- With four water channels to speed up water drainage
- Suitable for use when possible salt or chlorinated water contact, but not for full submersion

Product Code	Length	Diameter	Weight	Tube Material	Head Material	Max.Load
1-02-T2A1T-210-WRESIST	210mm	Ø30mm	158g	AL	TI	125kg

Tube with female pyramid adaptor (AK)

1-02-T2A1T-410-WRESIST



1-02-T2A1T-410-WRESIST



New!

1-02-T2A1T-410-WRESIST Tube with female pyramid adaptor (AK)

- Water resistant components
- Titanium/ Aluminium material
- With stainless steel corrosion resistant screw
- With four water channels to speed up water drainage
- Suitable for use when possible salt or chlorinated water contact, but not for full submersion

Product Code	Length	Diameter	Weight	Tube Material	Head Material	Max.Load
1-02-T2A1T-410-WRESIST	410mm	Ø30mm	260g	AL	TI	125kg

Regal Feet and Adaptors

Single-axis ankle adaptor

1-02-2ST/ 1-02-2SS/ 1-02-DB1



1-02-2ST



1-02-2SS



1-02-DB1
(bearing axis)

- 1-02-2ST and 1-02-2SS only comes with Black cushion, while 1-02-DB1 only comes with green cushion

Product Code	Size	Weight	Material	Max.Load
1-02-2ST-S	21-25cm	196g	TI	125kg
1-02-2ST-L	26-30cm	208g	TI	125kg
1-02-2SS-S	21-25cm	288g	SS	125kg
1-02-2SS-L	26-30cm	305g	SS	125kg
1-02-DB1	-	173g	AL	100kg

Heel cushion for
1-02-2ST and 1-02-2SS



1-02-2SS-01G



1-02-2SS-01B



1-02-2SS-01P

Heel cushion for
1-02-DB1



1-02-DB1-01

Product Code	Description	Hardness	Colour
1-02-2SS-01G	Heel cushion	Hard	Green
1-02-2SS-01P	Heel cushion	Med	Pink
1-02-2SS-01B	Heel cushion	Soft	Black
1-02-DB1-01	Heel cushion	-	Green

Tube adaptor

1-02-T3T/ 1-02-T3S



75mm

60mm

45mm

1-02-T3T/
1-02-T3S

Product Code	Height	Weight	Material	Max. Load
1-02-T3T-45	45mm	48g	TI	125kg
1-02-T3T-60	60mm	56g	TI	100kg
1-02-T3T-75	75mm	67g	TI	100kg
1-02-T3S-45	45mm	84g	SS	100kg
1-02-T3S-60	60mm	99g	SS	100kg
1-02-T3S-75	75mm	120g	SS	100kg

Tube with female pyramid adaptor (AK/BK)

1-02-T2A1T/ 1-02-T2A1S



1-02-T2A1T-210/
1-02-T2A1S-210



1-02-T2A1T-410/
1-02-T2A1S-410

Product Code	Length	Diameter	Weight	Tube material	Head material	Max. Load
1-02-T2A1T-210	210mm	Ø30mm	158g	AL	TI	100kg
1-02-T2A1S-210	210mm	Ø30mm	198g	AL	SS	125kg
1-02-T2A1T-410	410mm	Ø30mm	260g	AL	TI	100kg
1-02-T2A1S-410	410mm	Ø30mm	308g	AL	SS	125kg

Tube with female pyramid adaptor

1-02-BO200/ 1-02-BO250/ 1-02-BO400



1-02-BO200



1-02-BO400



1-02-BO250

Product Code	Length	Diameter	Weight	Material	Max. Load
1-02-BO200	200mm	Ø30mm	150g	AL	100kg
1-02-BO250	250mm	Ø30mm	179g	AL	100kg
1-02-BO400	400mm	Ø30mm	336g	AL	100kg

Tube with SACH ankle

1-02-BT200/ 1-02-BT400



1-02-BT200



1-02-BT400

Product Code	Length	Diameter	Weight	Material	Max. Load
1-02-BT200	200mm	Ø30mm	223g	AL	100kg
1-02-BT400	400mm	Ø30mm	336g	AL	100kg

Tube (pediatric)

0-02-BC150/ 0-02-BC300



0-02-BC150



0-02-BC300

Product Code	Length	Diameter	Weight	Material	Max. Load
0-02-BC150	150mm	Ø22mm	55g	AL	45kg
0-02-BC300	300mm	Ø22mm	125g	AL	45kg

Tube

1-02-B200/ 1-02-B400



1-02-B200



1-02-B400

Product Code	Length	Diameter	Weight	Material	Max. Load
1-02-B200	200mm	Ø30mm	118g	AL	100kg
1-02-B400	400mm	Ø30mm	298g	AL	100kg

Regal Feet and Adaptors

Carbon fiber tube (AK/BK)

1-02-C300/ 1-02-C355



1-02-C300



1-02-C355

Product Code	Length	Diameter	Weight	Material	Max. Load
1-02-C300	300mm	Ø30mm	115g	CF	125kg
1-02-C355	355mm	Ø30mm	133g	CF	125kg

Male socket adaptor

1-02-A1T/ 1-02-A1S/ 1-02-A1A



1-02-A1T



1-02-A1S



1-02-A1A

Product Code	Weight	Material	Max. Load
1-02-A1T	53g	TI	125kg
1-02-A1S	120g	SS	125kg
1-02-A1A	59g	AL	100kg

1-02-A1T-01/
1-02-A1S-01/
1-02-A1A-01



Lamination dummy

Product Code	Description
1-02-A1T-01	Lamination dummy
1-02-A1S-01	Lamination dummy
1-02-A1A-01	Lamination dummy

Socket adaptor

1-02-TO1/ 1-02-TO2



1-02-TO1



1-02-TO2

Product Code	Weight	Material	Max. Load
1-02-TO1	160g	AL	100kg
1-02-TO2	170g	AL	100kg

Female socket adaptor

1-02-A8T/ 1-02-A8S



1-02-A8T



1-02-A8S

Product Code	Weight	Material	Max. Load
1-02-A8T	57g	TI	100kg
1-02-A8S	96g	SS	100kg

Female socket adaptor (rotatable)

1-02-A8ZT/ 1-02-A8ZS



1-02-A8ZT



1-02-A8ZS

Product Code	Weight	4 prongs Material	Head Material	Max. Load
1-02-A8ZT	65g	SS	TI	100kg
1-02-A8ZS	117g	SS	SS	100kg

PU foam block

1-02-A22



1-02-A22

Product Code	Weight	Diameter	Material	Max. Load
1-02-A22	242g	115mm	Foam	-

PU foam block (diameter:75mm)

1-02-A22-75



1-02-A22-75

New!

Product Code	Weight	Diameter	Material	Max. Load
1-02-A22-75	275g	75mm	Foam	-

Wooden attachment block

1-02-A22W



1-02-A22W

Product Code	Weight	Material	Max. Load
1-02-A22W	-	Wood	-

Regal Feet and Adaptors

Male socket adaptor

1-02-A2T/ 1-02-A2S/ 1-02-A2A



1-02-A2T

1-02-A2S



1-02-A2A

Product Code	Weight	Material	Max. Load
1-02-A2T	43g	TI	125kg
1-02-A2S	117g	SS	125kg
1-02-A2A	56g	AL	100kg

Male socket adaptor (rotatable)

1-02-A2ZT/ 1-02-A2ZS



1-02-A2ZT



1-02-A2ZS

Product Code	Weight	Material	Max. Load
1-02-A2ZT	76g	TI	125kg
1-02-A2ZS	180g	SS	125kg

Female socket adaptor

1-02-A5T/ 1-02-A5S/ 1-02-A5A



1-02-A5T



1-02-A5S



1-02-A5A

Product Code	Weight	Material	Max. Load
1-02-A5T	46g	TI	125kg
1-02-A5S	104g	SS	125kg
1-02-A5A	44g	AL	100kg

Female socket adaptor (rotatable)

1-02-A5ZT/ 1-02-A5ZS/ 1-02-TA1



1-02-A5ZT



1-02-A5ZS



1-02-TA1

Product Code	Weight	Material	Max. Load
1-02-A5ZT	90g	TI	125kg
1-02-A5ZS	164g	SS	125kg
1-02-TA1	102g	AL	100kg

Pediatric

Feet & Adaptors

Knee joints & Hip Joints

Suspension Systems

Cosmetic, Tools & Materials

Orthotics & Rehabilitation

Upperlimbs Modular Prosthesis

FAQ & Warranty

Male socket adaptor

1-02-A12S



1-02-A12S



1-02-A12S-01

Product Code	Weight	Material	Max. Load
1-02-A12S	133g	SS	125kg

Product Code	Description
1-02-A12S-01	Lamination dummy

Male socket adaptor (rotatable)

1-02-A12ZT/ 1-02-A12ZS



1-02-A12ZT



1-02-A12ZS

Product Code	Weight	3 prongs Material	Head Material	Max. Load
1-02-A12ZT	154g	SS	TI	125kg
1-02-A12ZS	208g	SS	SS	125kg

Female socket adaptor (rotatable)

1-02-A11ZT/ 1-02-A11ZS/ 1-02-A11ZS-01



1-02-A11ZT



1-02-A11ZS

Product Code	Weight	3 prongs Material	Head Material	Max. Load
1-02-A11ZT	154g	SS	TI	125kg
1-02-A11ZS	190g	SS	SS	125kg



1-02-A11ZS-01

Product Code	Description	Weight	Material	Max Load.
1-02-A11ZS-01	3-prong adaptor	101g	SS	125kg

Pediatric

Feet & Adaptors

Knee joints & Hip Joints

Suspension Systems

Cosmetic, Tools & Materials

Orthotics & Rehabilitation

Upperlimbs Modular Prosthesis

FAQ & Warranty

Regal Feet and Adaptors

Male tube adaptor

1-02-A7T/ 1-02-A7S



1-02-A7T



1-02-A7S

Product Code	Weight	Material	Max. Load
1-02-A7T	60g	TI	100kg
1-02-A7S	122g	SS	100kg

Female tube adaptor

1-02-A6T/ 1-02-A6S/ 1-02-A6A



1-02-A6T



1-02-A6A



1-02-A6S

Product Code	Weight	Material	Max. Load
1-02-A6T	63g	TI	125kg
1-02-A6S	128g	SS	125kg
1-02-A6A	78g	AL	100kg

Offset tube clamp

1-02-A6TOFF



1-02-A6TOFF

1-02-A6TOFF Offset Tube Clamp

- The titanium 30mm offset tube clamp is used when extra alignment is needed
- It is also ideal when using a pin suspension lock, where prosthetic and pin alignment can be easily adjusted using the offset clamp
- This versatile clamp design also provides an offset position that can be rotated 360 degrees

Product Code	Weight	Material	Max. Load
1-02-A6TOFF	109g	TI	125kg

Angled tube adaptor

1-02-A10T/ 1-02-A10S



1-02-A10T



1-02-A10S

Product Code	Weight	Material	Max. Load
1-02-A10T	73g	TI	125kg
1-02-A10S	139g	SS	125kg

Pediatric

Feet & Adaptors

Knee joints & Hip Joints

Suspension Systems

Cosmetic, Tools & Materials

Orthotics & Rehabilitation

Upperlimbs Modular Prosthesis

FAQ & Warranty

Sliding tube clamp

1-02-A14T/ 1-02-A14S



1-02-A14T

1-02-A14S

1-02-A14T/1-02-A14S Sliding tube clamp

- 30mm sliding tube clamp adaptor
- Permits additional sliding adjustment between the prosthetic socket and tube adaptor, even as the prosthetic is being worn
- The sliding adjustment allows for fine turning in any desired parallel position of the distal portion, independent of the angle of adjustment through the pyramid

Product Code	Weight	Material	Max. Load
1-02-A14T	180g	TI	100kg
1-02-A14S	313g	SS	100kg

Double adaptor with adjusting of length

1-02-A15T/ 1-02-A15S



1-02-A15T/1-02-A15S

1-02-A15T/1-02-A15S Double adaptor with adjusting of length

- Suitable for TT and TF amputee with long residual limb
- The height could be adjusted from 60mm to 75mm

Product Code	Weight	Height	Material	Max. Load
1-02-A15T	133g	60-75mm	TI	100kg
1-02-A15S	214g	60-75mm	SS	100kg

Double adaptor

1-02-A3T/ 1-02-A3S



75mm

60mm

45mm

32mm

1-02-A3T/
1-02-A3S

Product Code	Weight	Material	Max. Load
1-02-A3T-32	63g	TI	125kg
1-02-A3T-45	72g	TI	125kg
1-02-A3T-60	84g	TI	125kg
1-02-A3T-75	90g	TI	125kg
1-02-A3S-32	126g	SS	125kg
1-02-A3S-45	158g	SS	125kg
1-02-A3S-60	177g	SS	125kg
1-02-A3S-75	202g	SS	125kg

Double adaptor

1-02-A4T/ 1-02-A4S



75mm

60mm

45mm

32mm

1-02-A4T/
1-02-A4S

Product Code	Weight	Material	Max. Load
1-02-A4T-32	70g	TI	125kg
1-02-A4T-45	82g	TI	125kg
1-02-A4T-60	93g	TI	125kg
1-02-A4T-75	103g	TI	125kg
1-02-A4S-32	142g	SS	125kg
1-02-A4S-45	186g	SS	125kg
1-02-A4S-60	216g	SS	125kg
1-02-A4S-75	246g	SS	125kg

Regal Feet and Adaptors

Pediatric

Feet &
Adaptors

Knee joints &
Hip Joints

Suspension
Systems

Cosmetic, Tools
& Materials

Orthotics &
Rehabilitation

Upperlimbs
Modular Prosthesis

FAQ & Warranty

Knee joints and Hip Joints



Pediatric 4 Bar knee joint (AK/KD)

0-00-4S41C

Pediatric

Feet & Adaptors

Knee joints & Hip Joints

Suspension Systems

Cosmetic, Tools & Materials

Orthotics & Rehabilitation

Upperlimbs Modular Prosthesis

FAQ & Warranty



0-00-4S41C

0-00-4S41C Pediatric 4 Bar knee joint (AK/KD)

- The knee joint is light weight 4 bar knee joint for pediatric
- Standard adaptor: Pyramid (AK)
- Optional adaptor: 3-prong adaptor (for KD)
- If you like to order maintenance part, please feel free to contact us



0-00-4S41C



0-00-4S41C=LA

Product Code	Weight	Material	Max. Load	Mobility Level
0-00-4S41C	320g	AL	55kg	II III
0-00-4S41C=LA	320g	AL	55kg	II III

Accessories



(AK)

0-00-4S41C-01

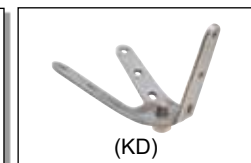

(KD)

0-00-4S41C=LA-01

Product Code	Material	Description
0-00-4S41C-01	SS	Pyramid adaptor(AK)
0-00-4S41C=LA-01	SS	3-prong adaptor (KD)

Pediatric 4 Bar knee joint with manual lock (AK/KD)

0-00-4S40C



0-00-4S40C

0-00-4S40C Pediatric 4 Bar knee joint with manual lock (AK/KD)

- The knee joint is light weight manual locking knee joint for pediatric with very low functional level
- Standard adaptor: Pyramid (AK)
- Optional adaptor: 3-prong adaptor (for KD)
- If you like to order maintenance part, please feel free to contact us



0-00-4S40C



0-00-4S40C=LA

Product Code	Weight	Material	Max. Load	Mobility Level
0-00-4S40C	387g	AL	55kg	II III
0-00-4S40C=LA	387g	AL	55kg	II III

Accessories

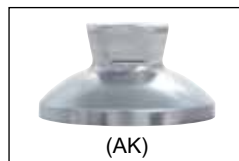

(AK)

0-00-4S40C-01

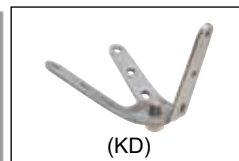

(KD)

0-00-4S40C=LA-01

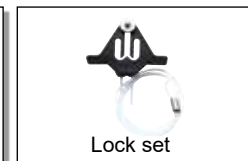

Lock set

0-00-4S40C-02

Product Code	Material	Description
0-00-4S40C-01	SS	Pyramid adaptor(AK)
0-00-4S40C=LA-01	SS	3-prong adaptor (KD)
0-00-4S40C-02	-	Lock set

Pediatric aluminium polycentric mechanical hip joint

0-00-H1C

Pediatric

Feet & Adaptors

Knee joints & Hip Joints

Suspension Systems

Cosmetic, Tools & Materials

Orthotics & Rehabilitation

Upperlimbs Modular Prosthesis

FAQ & Warranty



0-00-H1C

0-00-H1C Pediatric aluminium polycentric mechanical hip joint

- lightweight design

Product Code	Weight	Material	Max. Load
0-00-H1C	550g	AL	55kg



0-00-H1C-01

Product Code	Description
0-00-H1C-01	Anchor plate

Single axis knee joint (pediatric)

0-00-4S30C



0-00-4S30C

0-00-4S30C Single axis knee joint (pediatric)

- Lightweight aluminum single axis
- Pediatric knee joint with proximal adjustment pyramid and distal tube clamp
- Proximal connection: adjustment pyramid
- Distal connection: tube clamp Ø 22mm

Product Code	Weight	Material	Max. Load	Mobility Level
0-00-4S30C	160g	AL	45kg	I

Polycentric 5 Bar manual locking knee joint w/ stance flexion (AK/KD) 2-01-S700L



2-01-S700L

2-01-S700L

Polycentric 5 Bar manual locking knee joint with stance flexion (AK/KD)

The new standard in safety knees

This NEW knee is not the friction braking knee of old. This geometrically aligned system never fails in stability

The S700L is a polycentric manual locking knee with stance flexion. The stance flexion system forces the geometry into a very stable position at heel contact until the patient rolls over the toe to release the knee into swing. The knee can be flexed in stance while providing stance stability. Elegantly simplistic design for stability. With correct alignment the knee is always in a stable position for patient confidence.

- Adjustable stance flexion from extreme stability with high stance flexion of up to 12 degrees
- Rapid response with low stance flexion
- Adjustable constant friction for swing phase resistance. Adjustable extension assist for swing phase
- Lock is manually released by pulling on the lanyard which is attached to the knee lock mechanism
- Lock mechanism can also be removed at a later time so that the knee can be used as a free swing knee
- Usable for either above knee or knee disarticulation
- Best suited to be used for K1-K2
- The frame construction is made of superlight aluminum alloy
- The proximal attachments has A-P slide and Rotation adjustment
- Standard adaptor: Pyramid (AK)
- Optional adaptor: Lotus (KD) and Socket Attachment plate (KD)
- Lanyard is included with the purchase of the S700L



2-01-S700L

2-01-S700L=LA

2-01-S700L=SP

Product Code	Weight	Material	Max. Load	Mobility Level
2-01-S700L	852g	AL	125kg	II
2-01-S700L=LA	869g	AL	125kg	II
2-01-S700L=SP	842g	AL	100kg	II

Accessories



Pyramid adaptor(AK)

2-01-S700L-01



Lotus adaptor(KD)

2-01-S700L=LA-01

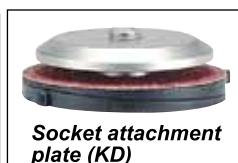

Socket attachment plate (KD)

2-01-S700L=SP-01



Lock set

2-01-S700L-02

Product Code	Material	Description
2-01-S700L-01	AL	Pyramid adaptor(AK)
2-01-S700L=LA-01	AL	Lotus adaptor(KD)
2-01-S700L=SP-01	AL	Socket attachment plate(KD)
2-01-S700L-02	-	Lock set

Polycentric 5 Bar knee joint with stance flexion (AK/KD)

2-01-S700



2-01-S700

2-01-S700

Polycentric 5 Bar knee joint with stance flexion (AK/KD)

The new standard in safety knees

This NEW knee is not the friction braking knee of old. This geometrically aligned system never fails in stability

The S700 polycentric K2 knee with stance flexion system forces the geometry into a very stable position at heel contact until the patient rolls over the toe to release the knee into swing. The knee can be flexed in stance up to 12 degrees while providing stance stability. Elegantly simplistic design for stability. With correct alignment the knee is always in a stable position for patient confidence.

- Adjustable stance flexion from extreme stability with high stance flexion of up to 12 degrees to a very rapid response with low stance flexion
- Adjustable constant friction for swing phase resistance
- Adjustable extension assist for swing phase
- Usable for either above knee or knee disarticulation
- Best suited to be used for K1-K2
- The frame construction is made of superlight aluminum alloy
- The proximal attachments has A-P slide and Rotation adjustment
- Standard adaptor: Pyramid (AK)
- Optional adaptor: Lotus (KD) and Socket Attachment plate (KD)



2-01-S700

2-01-S700=LA

2-01-S700=SP

Product Code	Weight	Material	Max. Load	Mobility Level
2-01-S700	782g	AL	125kg	II
2-01-S700=LA	799g	AL	125kg	II
2-01-S700=SP	772g	AL	100kg	II

Accessories



Pyramid adaptor(AK)

2-01-S700-01



Lotus adaptor(KD)

2-01-S700=LA-01



Socket attachment plate (KD)

2-01-S700=SP-01

Product Code	Material	Description
2-01-S700-01	AL	Pyramid adaptor(AK)
2-01-S700=LA-01	AL	Lotus adaptor(KD)
2-01-S700=SP-01	AL	Socket attachment plate(KD)

Pediatric

Feet & Adaptors

Knee joints & Hip Joints

Suspension Systems

Cosmetic, Tools & Materials

Orthotics & Rehabilitation

Upperlimbs Modular Prosthesis

FAQ & Warranty



2-01-S600

2-01-S600

Polycentric 5 Bar pneumatic knee joint with stance flexion (AK/KD)

The S600, is designed to be a very stable 5 Bar Knee with a large stance flexion angle (up to 12°). Weighing in at less than 1KG and having extensive alignment adjusting abilities give the S600 knee a smooth and natural gait pattern.

The frame construction is made of superlight aluminum alloy. All axes have built-in bearing which allow for ultra smooth walking movement. The proximal attachment has A-P slide and Rotation adjustment.

- Polycentric knee with stance flexion control for maximum safety during stance and is best suited to be used for low to high K3 level
- Practitioner adjustable from extreme stability to high stance flexion
- The S600 offers a pneumatic cylinder with independent flexion extension adjustment for swing phase
- Can be used for either above knee or knee disarticulation
- Standard adaptor: Pyramid (AK)
- Optional adaptor: Lotus (KD) and Socket Attachment plate (KD)



2-01-S600



2-01-S600=LA



2-01-S600=SP

Product Code	Weight	Material	Max. Load	Mobility Level
2-01-S600	982g	AL	125kg	II III
2-01-S600=LA	999g	AL	125kg	II III
2-01-S600=SP	972g	AL	100kg	II III

Accessories



2-01-S600-01



2-01-S600=LA-01



2-01-S600=SP-01

Product Code	Material	Description
2-01-S600-01	AL	Pyramid adaptor(AK)
2-01-S600=LA-01	AL	Lotus adaptor(KD)
2-01-S600=SP-01	AL	Socket attachment plate(KD)

Polycentric 4 Bar pneumatic knee joint (AK/KD)

2-01-S500



2-01-S500

2-01-S500 Polycentric 4 Bar pneumatic knee joint (AK/KD)

The S500 knee joint is a polycentric knee with pneumatic swing control that is best suited to be used for moderate to K3 level activity and high need for safety. The frame construction is made of superlight aluminum alloy.

- Polycentric knee joint with pneumatic swing control
- Independent flexion / extension adjustment
- Built-in bearings which allow for ultra smooth walking movement
- Frame construction made of superlight aluminum alloy
- Proximal attachment has A-P slide and rotating adjustment
- Adjustable Extension assist
- Standard adaptor: Pyramid (AK)
- Optional adaptor: Lotus (KD) and Socket Attachment plate (KD)



2-01-S500



2-01-S500=LA



2-01-S500=SP

Product Code	Weight	Material	Max. Load	Mobility Level
2-01-S500	882g	AL	125kg	II III
2-01-S500=LA	899g	AL	125kg	II III
2-01-S500=SP	872g	AL	100kg	II III

Accessories



Pyramid adaptor(AK)

2-01-S500-01



Lotus adaptor(KD)

2-01-S500=LA-01



Socket attachment plate (KD)

2-01-S500=SP-01

Product Code	Material	Description
2-01-S500-01	AL	Pyramid adaptor(AK)
2-01-S500=LA-01	AL	Lotus adaptor(KD)
2-01-S500=SP-01	AL	Socket attachment plate(KD)

Pediatric

Feet & Adaptors

Knee joints & Hip Joints

Suspension Systems

Cosmetic, Tools & Materials

Orthotics & Rehabilitation

Upperlimbs Modular Prosthesis

FAQ & Warranty

Polycentric 4 Bar manual locking knee joint (AK/KD)

2-01-S400L



2-01-S400L

2-01-S400L Polycentric 4 Bar manual locking knee joint (AK/KD)

The S400L knee joint is a manual locking, polycentric 4 bar linkage knee with friction swing phase control. The lock is manually released by pulling on the lanyard which is attached to the knee lock mechanism. The knee lock mechanism can also be removed at a later time so that the knee can be used as a free swing knee. Swing phase resistance is controlled by amount of friction applied on the axis of the knee.

- Manual locking polycentric knee
- Lanyard lock mechanism can be removed at a later time so that the knee can be used as a free swing knee
- Low activity
- High need for security
- Frame construction is made of superlight aluminum alloy
- Best suited to be used for K1-K2
- Proximal attachment has A-P slide and rotation adjustment
- Standard adaptor: Pyramid (AK)
- Optional adaptor: Lotus (KD) and Socket Attachment plate (KD)
- Lanyard is included with the purchase of the S400L



2-01-S400L

2-01-S400L=LA

2-01-S400L=SP

Product Code	Weight	Material	Max. Load	Mobility Level
2-01-S400L	678g	AL	125kg	II
2-01-S400L=LA	695g	AL	125kg	II
2-01-S400L=SP	668g	AL	100kg	II

Accessories



Pyramid adaptor(AK)

2-01-S400L-01



Lotus adaptor(KD)

2-01-S400L=LA-01



Socket attachment plate (KD)

2-01-S400L=SP-01



Lock set

2-01-S400L-02

Product Code	Material	Description
2-01-S400L-01	AL	Pyramid adaptor(AK)
2-01-S400L=LA-01	AL	Lotus adaptor(KD)
2-01-S400L=SP-01	AL	Socket attachment plate(KD)
2-01-S400L-02	-	Lock set

Polycentric 4 Bar knee joint (AK/KD)

2-01-S400



2-01-S400

2-01-S400 Polycentric 4 Bar knee joint (AK/KD)

The S400 knee joint is a polycentric knee that is best suited to be used for moderate to K2 level activity and high need for safety.

- Polycentric knee
- Constant friction swing phase control
- Frame construction is made of superlight aluminum alloy
- Proximal attachment has A-P slide and rotation adjustment
- Standard adaptor: Pyramid (AK)
- Optional adaptor: Lotus (KD) and Socket Attachment plate (KD)



2-01-S400



2-01-S400=LA



2-01-S400=SP

Product Code	Weight	Material	Max. Load	Mobility Level
2-01-S400	650g	AL	125kg	II
2-01-S400=LA	667g	AL	125kg	II
2-01-S400=SP	640g	AL	100kg	II

Accessories



2-01-S400-01



2-01-S400=LA-01



2-01-S400=SP-01

Product Code	Material	Description
2-01-S400-01	AL	Pyramid adaptor(AK)
2-01-S400=LA-01	AL	Lotus adaptor(KD)
2-01-S400=SP-01	AL	Socket attachment plate(KD)

Pediatric

Feet & Adaptors

Knee joints & Hip Joints

Suspension Systems

Cosmetic, Tools & Materials

Orthotics & Rehabilitation

Upperlimbs Modular Prosthesis

FAQ & Warranty

Polycentric 4 Bar linkage knee joint (AK/KD)

2-01-A41



2-01-A41

2-01-A41

Polycentric 4 Bar linkage knee joint (AK)

- Polycentric 4 bar knee
- Constant friction swing phase control
- Best suited for low activity level
- High need for security
- Frame construction is made of superlight aluminum alloy
- Proximal attachment has A-P slide and rotation adjustment
- Standard adaptor: Pyramid (AK)
- Optional adaptor: Lotus (KD) and Socket Attachment plate (KD)



2-01-A41



2-01-A41=LA



2-01-A41=SP

Product Code	Weight	Material	Max. Load	Mobility Level
2-01-A41	559g	AL	100kg	II
2-01-A41=LA	576g	AL	100kg	II
2-01-A41=SP	549g	AL	100kg	II

Accessories



Pyramid adaptor(AK)

2-01-A41-01



Lotus adaptor(KD)

2-01-A41=LA-01



Socket attachment plate (KD)

2-01-A41=SP-01

Product Code	Material	Description
2-01-A41-01	AL	Pyramid adaptor(AK)
2-01-A41=LA-01	AL	Lotus adaptor(KD)
2-01-A41=SP-01	AL	Socket attachment plate(KD)

Pneumatic 4 Bar knee joint with integrated pyramid

2-01-KA5



2-01-KA5

2-01-KA5 Pneumatic 4 Bar knee joint with integrated pyramid

- The knee joint is a polycentric knee joint best suited for use with low to constant walking speed while providing a higher degree of safety
- This frame construction is made of superlight aluminum alloy and incorporates swing phase control with independent flexion/extension adjustment

Product Code	Weight	Material	Max. Load	Mobility Level
2-01-KA5	731g	AL	100kg	II III

4 Bar mechanical knee joint (AK)

2-01-4S3T/ 2-01-4S3S



2-01-4S3T/
2-01-4S3S

2-01-4S3T/2-01-4S3S 4 Bar mechanical knee joint (AK)

- Viscous-elastic swing
- Max.load: 100kg
- If you like to order maintenance part, please feel free to contact us

Product Code	Weight	Material	Max. Load
2-01-4S3T	453g	TI	100kg
2-01-4S3S	662g	SS	125kg

Pediatric

Feet & Adaptors

Knee joints & Hip Joints

Suspension Systems

Cosmetic, Tools & Materials

Orthotics & Rehabilitation

Upperlimbs Modular Prosthesis

FAQ & Warranty

4 Bar mechanical knee joint (KD)

2-01-4S21



2-01-4S21

2-01-4S21 4 Bar mechanical knee joint (KD)

- Basic level mechanical 4 linkages
- If you like to order maintenance part, please feel free to contact us

Product Code	Weight	Material	Max. Load
2-01-4S21	870g	SS	100kg



2-01-4S21-01

Product Code	Description
2-01-4S21-01	Anchor plate

4 Bar mechanical knee joint with lock (KD)

2-01-4S23



2-01-4S23

2-01-4S23 4 Bar mechanical knee joint with lock (KD)

- Basic level mechanical 4 linkages
- With cable manual lock
- If you like to order maintenance part, please feel free to contact us

Product Code	Weight	Material	Max. Load
2-01-4S23	896g	SS	100kg



2-01-4S23-02



2-01-4S23-01

Product Code	Description
2-01-4S23-01	Anchor plate
2-01-4S23-02	Lock set

Pediatric

Feet & Adaptors

Knee joints & Hip Joints

Suspension Systems

Cosmetic, Tools & Materials

Orthotics & Rehabilitation

Upperlimbs Modular Prosthesis

FAQ & Warranty

Single axis lock knee joint (AK)

2-01-4S40

Pediatric



2-01-4S40

2-01-4S40-01

2-01-4S40 Single axis lock knee joint (AK)

- CNC machined
- Good lock design
- If you like to order maintenance part, please feel free to contact us

Product Code	Weight	Material	Max. Load	Mobility Level
2-01-4S40	278g	AL	100kg	I

Product Code	Description
2-01-4S40-01	Lock set

Single axis knee joint with manual lock

2-01-4S33/ 2-01-4S17

Feet & Adaptors

Knee joints & Hip Joints

Suspension Systems

Cosmetic, Tools & Materials

Orthotics & Rehabilitation

Upperlimbs Modular Prosthesis

FAQ & Warranty



2-01-4S33/
2-01-4S17



2-01-4S33-01/
2-01-4S17-01

2-01-4S33 / 2-01-4S17 Single axis knee joint with manual lock

- With manual lock
- Integrated Extension Assist
- If you like to order maintenance part, please feel free to contact us

Product Code	Weight	Material	Max. Load
2-01-4S33	408g	TI	100kg
2-01-4S17	586g	SS	125kg

Product Code	Description
2-01-4S33-01	Lock set
2-01-4S17-01	Lock set

Single axis knee joint

2-01-4S34/ 2-01-4S22



2-01-4S34/
2-01-4S22

2-01-4S34 / 2-01-4S22 Single axis knee joint

- Integrated Extension Assist
- If you like to order maintenance part, please feel free to contact us

Product Code	Weight	Material	Max. Load
2-01-4S34	408g	TI	100kg
2-01-4S22	590g	SS	100kg

Single axis lock knee joint

2-01-3S40



2-01-3S40



2-01-3S40-01

2-01-3S40 Single axis lock knee joint

- CNC machined
- Light aluminum alloy
- If you like to order maintenance part, please feel free to contact us

Product Code	Weight	Material	Max. Load	Mobility Level
2-01-3S40	394g	AL	100kg	I

Product Code	Description
2-01-3S40-01	Lock set

Single axis lock knee joint (AK)

2-01-4S40J



2-01-4S40J



2-01-4S40J-01

2-01-4S40J Single axis lock knee joint (AK)

- CNC machined
- Good lock design
- Rotatable pyramid adaptor
- If you like to order maintenance part, please feel free to contact us



360 degree rotatable horizontal upper pyramid

Product Code	Weight	Material	Max. Load	Mobility Level
2-01-4S40J	358g	AL	100kg	I

Product Code	Description
2-01-4S40J-01	Lock set

Pediatric

Feet & Adaptors

Knee joints & Hip Joints

Suspension Systems

Cosmetic, Tools & Materials

Orthotics & Rehabilitation

Upperlimbs Modular Prosthesis

FAQ & Warranty

Single axis knee joint (with stance control and constant friction) 2-01-4S1T/ 2-01-4S1S

Pediatric



2-01-4S1T/
2-01-4S1S

2-01-4S1T / 2-01-4S1S Single axis knee joint with stance control and constant friction

- with stance control and constant friction
- with weight bears braking mechanism
- If you like to order maintenance part, please feel free to contact us

Product Code	Weight	Material	Max. Load
2-01-4S1T	358g	TI	125kg
2-01-4S1S	528g	SS	125kg

Feet & Adaptors

Knee joints & Hip Joints



2-01-4S1T-01/
2-01-4S1S-01



2-01-4S1T-02/
2-01-4S1S-02

Product Code	Description
2-01-4S1T-01	Extension Assist
2-01-4S1S-01	Extension Assist
2-01-4S1T-02	Cable
2-01-4S1S-02	Cable

Suspension Systems

Single axis knee joint

2-01-4S2T/ 2-01-4S2S



4S2T/
4S2S

2-01-4S2T / 2-01-4S2S Single axis knee joint

- If you like to order maintenance part, please feel free to contact us

Product Code	Weight	Material	Max. Load
2-01-4S2T	274g	TI	100kg
2-01-4S2S	380g	SS	100kg

Cosmetic, Tools & Materials

Orthotics & Rehabilitation

Upperlimbs Modular Prosthesis



2-01-4S2T-01/
2-01-4S2S-01



2-01-4S2T-02/
2-01-4S2S-02

Product Code	Description
2-01-4S2T-01	Extension Assist
2-01-4S2S-01	Extension Assist
2-01-4S2T-02	Wire
2-01-4S2S-02	Wire

FAQ & Warranty

Aluminium polycentric mechanical hip joint

2-02-H1



2-02-H1

2-02-H1 Aluminium polycentric mechanical hip joint

- Super lightweight design
- If you like to order maintenance part, please feel free to contact us

Product Code	Weight	Material	Max. Load
2-02-H1	740g	AL	100kg



2-02-H1-01

Product Code	Description
2-02-H1-01	Anchor plate

Stainless steel single axis mechanical hip joint

2-02-H1S

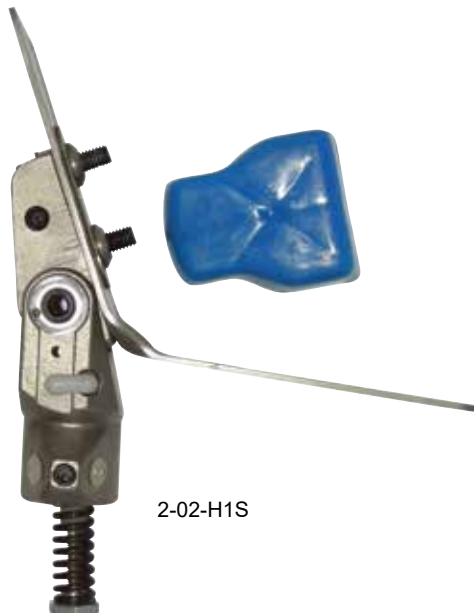

2-02-H1S

2-02-H1S Stainless steel single axis mechanical hip joint

- Basic level mechanical single axis hip joint
- If you like to order maintenance part, please feel free to contact us

Product Code	Weight	Material	Max. Load
2-02-H1S	887g	SS	100kg



2-02-H1S-01

Product Code	Description
2-02-H1S-01	Anchor plate

Pediatric

Feet & Adaptors

Knee joints & Hip Joints

Suspension Systems

Cosmetic, Tools & Materials

Orthotics & Rehabilitation

Upperlimbs Modular Prosthesis

FAQ & Warranty

Single axis mechanical hip joint with lock

2-02-H1SL

Pediatric

Feet & Adaptors

Knee joints & Hip Joints

Suspension Systems

Cosmetic, Tools & Materials

Orthotics & Rehabilitation

Upperlimbs Modular Prosthesis

FAQ & Warranty



2-02-H1SL



2-02-H1SL-01

2-02-H1SL Single axis mechanical hip joint with lock (stainless steel & aluminum)

- For hip disarticulation and hemi-pelvectomy amputees with lower functional levels
- Higher stance phase stability, minimal swing phase control

Product Code	Side	Weight	Material	Max. Load
2-02-H1SL-L	Left	851g	SS+AL	100kg
2-02-H1SL-R	Right	851g	SS+AL	100kg

Product Code	Description
2-02-H1SL-01	Anchor plate

Suspension Systems



3-01-3180M / 3-01-3181MP

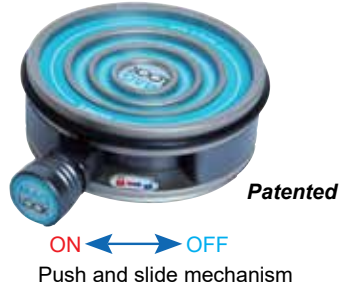

3-01-3180M / 3-01-3181MP Mechanical MAGLOCK & MAGLOCK Plus

- **INTRODUCING THE NEWLY DESIGNED**
- **LOW PROFILE, NO BATTERY – NO WIRES**
- The MAGLOCK & MAGLOCK PLUS have been designed to ease the frustration of donning a pin lock liner for patients K1 to K3
- The MAGLOCK achieves up to 60 lbs of suspension strength while the MAGLOCK Plus achieves up to 90lbs
- The large distal target allows the patient to be 10 degrees off center and still achieve suspension
- Neither version requires any maintenance, no charging and offers a fail safe way to turn on and off the magnetic system
- The ultimate product for patients who have dexterity issues, issues with pin alignment, requires a caregiver or looking for a suspension system that offers an easier option for suspension
- Mechanical MAGLOCK = 3-01-3180M
- Mechanical MAGLOCK Plus = 3-01-3181MP

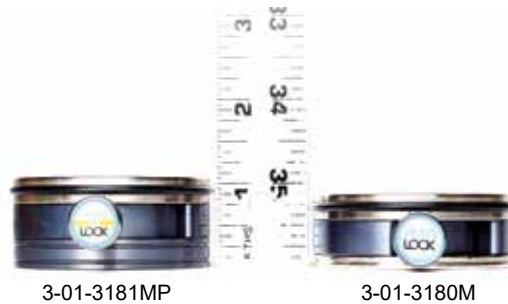

Product Code	Weight Limit	Product Weight	Build Height	Suspension Strength
3-01-3180M	136kg / 300lbs	278g / 0.6lbs	2.2cm / 0.87in	60lbs
3-01-3181MP	136kg / 300lbs	312g / 0.6lbs	2.72cm / 1.07in	90lbs

Refer to "Instructional video" from our website www.regalprosthesis.com

Pediatric

Feet & Adaptors

Knee joints & Hip Joints

Suspension Systems

Cosmetic, Tools & Materials

Orthotics & Rehabilitation

Upperlimbs Modular Prosthesis

FAQ & Warranty

Dummy for mechanical MAGLOCK & MAGLOCK Plus 3-01-3180-MDN/ 3-01-3181-MDN



3-01-3180-MDN / 3-01-3181-MDN

3-01-3180-MDN / 3-01-3181-MDN Dummy for mechanical MAGLOCK & MAGLOCK Plus

- Fabrication Dummy for MAGLOCK & MAGLOCK PLUS
- Comes with different sized silicon rings for casting over a MAGLiner or when using the Distal Cap converter for a locking liner
- These rings provide the perfect spacing and alignment of the MAGLOCK
- The Fabrication Dummy comes with two silicone rings
- Dummy for Mechanical MAGLOCK = 3-01-3180-MDN
- Dummy for Mechanical MAGLOCK Plus = 3-01-3181-MDN



Product Code	Description
3-01-3180-MDN	Dummy for Mechanical MAGLOCK (3-01-3180M)
3-01-3181-MDN	Dummy for Mechanical MAGLOCK Plus (3-01-3181MP)

Distal Cap converter for all pin liners 3-01-DSTCN



3-01-DSTCN

3-01-DSTCN Distal Cap converter for all pin liners

- Cap converter with 10 mm thread for all pin liners
- The distal cap converter is required for use with other liners in order to be compatible with the MAGLOCK
- DSTC comes with two silicone rings



Product Code
3-01-DSTCN

TRANSTIBIAL MAGLiner – Premier (BK)

3-01-MAG40

Pediatric

Feet & Adaptors

Knee joints & Hip Joints

Suspension Systems

Cosmetic, Tools & Materials

Orthotics & Rehabilitation

Upperlimbs Modular Prosthesis

FAQ & Warranty



3-01-MAG40 TRANSTIBIAL MAGLiner – Premier (BK)

Exclusively designed for the MAGLOCK

- This premium liner is designed for the health of the residual limb and ease of donning
- Manufactured with mineral oil embedded Platinum cured medical grade silicone and sheathed in a seamless durable fabric
- The matrix which is built into the liner prevents distal elongation
- 6 months warranty

Using the MAGLINER with the MAGLOCK offers the lowest profile possible

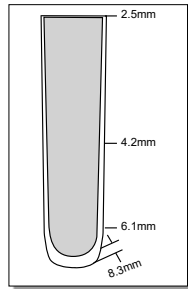
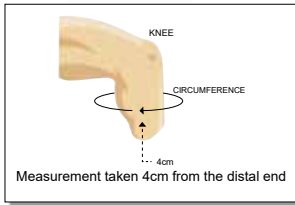

Product Code	Circumference	Length
3-01-MAG40-18	180mm	360mm
3-01-MAG40-20	200mm	360mm
3-01-MAG40-22	220mm	360mm
3-01-MAG40-23.5	235mm	360mm
3-01-MAG40-25	250mm	360mm
3-01-MAG40-26.5	265mm	360mm
3-01-MAG40-28	280mm	360mm
3-01-MAG40-30	300mm	360mm
3-01-MAG40-32	320mm	360mm
3-01-MAG40-34	340mm	360mm
3-01-MAG40-36	360mm	360mm

MAGLiners, PREMIER & HYDRO are designed exclusively for the MAGLOCK Suspension System.

The MAGLOCK eases the frustration of donning a pin lock liner for patients K1 to K3. The MAGLOCK is developed using a rare earth magnet which achieves up to 90lbs of adhesion. The large distal target allows the patient to be 10 degrees off center and still get suspension.

TRANSTIBIAL MAGLiner – Hydro (BK)

3-01-MAG30



3-01-MAG30

3-01-MAG30 TRANSTIBIAL MAGLiner – Hydro (BK)

Exclusively designed for the MAGLOCK

- *Regal* Prosthesis revolutionized the liner industry with the use of Parylene® on the surface of the silicone liner. We were also the first to encapsulate the outer cloth into the liner. We have eliminated delamination. We have designed a new cloth specially for this process
- The Hydro MAGLiner's silky smooth mineral oil embedded Platinum cured medical grade silicone liner has the unique ability to repel water. This hydrophobic property makes the Hydro the easiest and fastest liner to clean and sanitize
- The Parylene® surface reduces surface friction between the liner/skin and liner/socket for better comfort and donning. The Hydro MAGLiner reduces skin shear for fragile skin and will help with blister reduction. The matrix which is built into the liner prevents distal elongation and delamination
- The Hydro Skin offers proprietary donning and doffing strips to aid the patient in easier application/removal. It is suitable for moderate to high activity patients who require cushioning over sensitive areas in the socket. The Hydro Skin liner's opaque pigment gives a natural "skin tone" to all ethnic skin types
- 6 Month warranty

Using the MAGLINER with the MAGLOCK offers the lowest profile possible

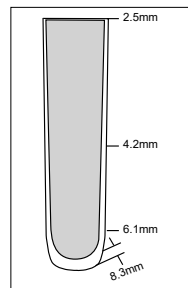
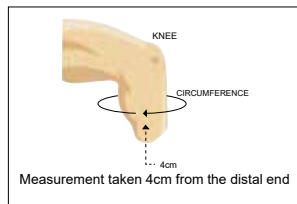

Product Code	Circumference	Length
3-01-MAG30-18	180mm	370mm
3-01-MAG30-20	200mm	370mm
3-01-MAG30-22	220mm	370mm
3-01-MAG30-23.5	235mm	370mm
3-01-MAG30-25	250mm	370mm
3-01-MAG30-26.5	265mm	370mm
3-01-MAG30-28	280mm	370mm
3-01-MAG30-30	300mm	370mm
3-01-MAG30-32	320mm	370mm
3-01-MAG30-34	340mm	370mm
3-01-MAG30-36	360mm	370mm

MAGLiners, PREMIER & HYDRO are designed exclusively for the MAGLOCK Suspension System.

The MAGLOCK eases the frustration of donning a pin lock liner for patients K1 to K3. The MAGLOCK is developed using a rare earth magnet which achieves up to 90lbs of adhesion. The large distal target allows the patient to be 10 degrees off center and still get suspension.

Pediatric

Feet & Adaptors

Knee joints & Hip Joints

Suspension Systems

Cosmetic, Tools & Materials

Orthotics & Rehabilitation

Upperlimbs Modular Prosthesis

FAQ & Warranty



3-01-MAG60

3-01-MAG60 TRANSFEMORAL MAGLiner – Premier (AK)

Exclusively designed for the MAGLOCK

- This premium liner is designed for the health of the residual limb and ease of donning
- Manufactured with mineral oil embedded Platinum cured medical grade silicone and sheathed in a seamless durable fabric
- The matrix which is built into the liner prevents distal elongation
- 6 months warranty

Using the MAGLINER with the MAGLOCK offers the lowest profile possible

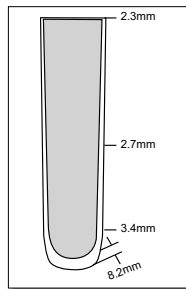
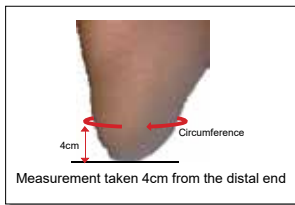

Product Code	Circumference	Length
3-01-MAG60-30	300mm	370mm
3-01-MAG60-32	320mm	370mm
3-01-MAG60-34	340mm	370mm
3-01-MAG60-36	360mm	370mm
3-01-MAG60-38	380mm	370mm
3-01-MAG60-40	400mm	370mm
3-01-MAG60-45	450mm	370mm

MAGLiners, PREMIER & HYDRO are designed exclusively for the MAGLOCK Suspension System.

The MAGLOCK eases the frustration of donning a pin lock liner for patients K1 to K3. The MAGLOCK is developed using a rare earth magnet which achieves up to 90lbs of adhesion. The large distal target allows the patient to be 10 degrees off center and still get suspension.

TRANSFEMORAL MAGLiner – Hydro (AK)

3-01-MAG50



3-01-MAG50

3-01-MAG50 TRANSFEMORAL MAGLiner – Hydro (AK)

Exclusively designed for the MAGLOCK

- Regal Prosthesis revolutionized the liner industry with the use of Parylene® on the surface of the silicone liner. We were also the first to encapsulate the outer cloth into the liner. We have eliminated delamination. We have designed a new cloth specially for this process
- The Hydro MAGLiner's silky smooth mineral oil embedded Platinum cured medical grade silicone liner has the unique ability to repel water. This hydrophobic property makes the Hydro the easiest and fastest liner to clean and sanitize
- The Parylene® surface reduces surface friction between the liner/sock and liner/socket for better comfort and donning. The Hydro MAGLiner reduces skin shear for fragile skin and will help with blister reduction. The matrix which is built into the liner prevents distal elongation and delamination
- The Hydro Skin offers proprietary donning and doffing strips to aid the patient in easier application/removal. It is suitable for moderate to high activity patients who require cushioning over sensitive areas in the socket. The Hydro Skin liner's opaque pigment gives a natural "skin tone" to all ethnic skin types
- 6 Month warranty

Using the MAGLINER with the MAGLOCK offers the lowest profile possible

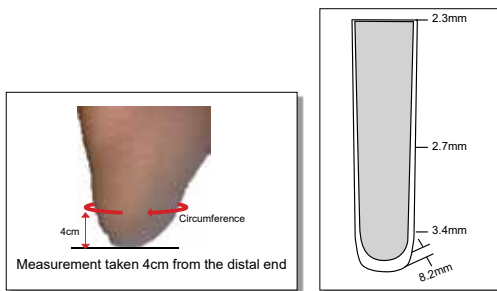

Product Code	Circumference	Length
3-01-MAG50-30	300mm	370mm
3-01-MAG50-32	320mm	370mm
3-01-MAG50-34	340mm	370mm
3-01-MAG50-36	360mm	370mm
3-01-MAG50-38	380mm	370mm
3-01-MAG50-40	400mm	370mm
3-01-MAG50-45	450mm	370mm

MAGLiners, PREMIER & HYDRO are designed exclusively for the MAGLOCK Suspension System.

The MAGLOCK eases the frustration of donning a pin lock liner for patients K1 to K3. The MAGLOCK is developed using a rare earth magnet which achieves up to 90lbs of adhesion. The large distal target allows the patient to be 10 degrees off center and still get suspension.

Pediatric

Feet & Adaptors

Knee joints & Hip Joints

Suspension Systems

Cosmetic, Tools & Materials

Orthotics & Rehabilitation

Upperlimbs Modular Prosthesis

FAQ & Warranty

New!

3-01-3012

TRANSTIBIAL Soft Silicone Liner - ADAPT (BK)

- The ADAPT liner is a silicone gel liner embedded with mineral oil providing skin healing factors. The soft gel with flexible fabric allows snug fit of various contours without restriction. The liner conforms very nicely while providing comfort. It is suitable for moderate to high activity patients. The matrix which is built into the liner prevents distal elongation of the liner for locking application
- 6 months warranty

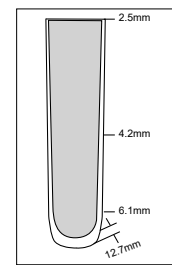
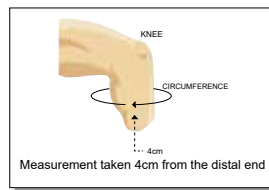
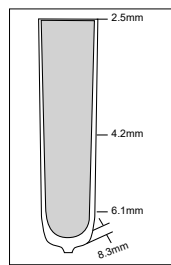

TRANSTIBIAL Locking liner

Product Code	Circumference	Length
3-01-3012L-18	180mm	370mm
3-01-3012L-20	200mm	370mm
3-01-3012L-22	220mm	370mm
3-01-3012L-23.5	235mm	370mm
3-01-3012L-25	250mm	370mm
3-01-3012L-26.5	265mm	370mm
3-01-3012L-28	280mm	370mm
3-01-3012L-30	300mm	370mm
3-01-3012L-32	320mm	370mm
3-01-3012L-34	340mm	370mm
3-01-3012L-36	360mm	370mm

TRANSTIBIAL Cushion liner

Product Code	Circumference	Length
3-01-3012C-18	180mm	360mm
3-01-3012C-20	200mm	360mm
3-01-3012C-22	220mm	360mm
3-01-3012C-23.5	235mm	360mm
3-01-3012C-25	250mm	360mm
3-01-3012C-26.5	265mm	360mm
3-01-3012C-28	280mm	360mm
3-01-3012C-30	300mm	360mm
3-01-3012C-32	320mm	360mm
3-01-3012C-34	340mm	360mm
3-01-3012C-36	360mm	360mm

3-01-3010 TRANSTIBIAL Silicone Liner (BK)

- The Forte liner is a silicone gel liner with mineral oil embedded in the silicone providing additional healing factor to the skin. The liner is made of medical grade silicone and durable seamless fabric on the outside for easy donning and doffing application. The liner comes with cushion and locking options. It is suitable for low to moderate activity patients. The matrix which is built into the liner prevents distal elongation of the liner for locking application
- 6 months warranty

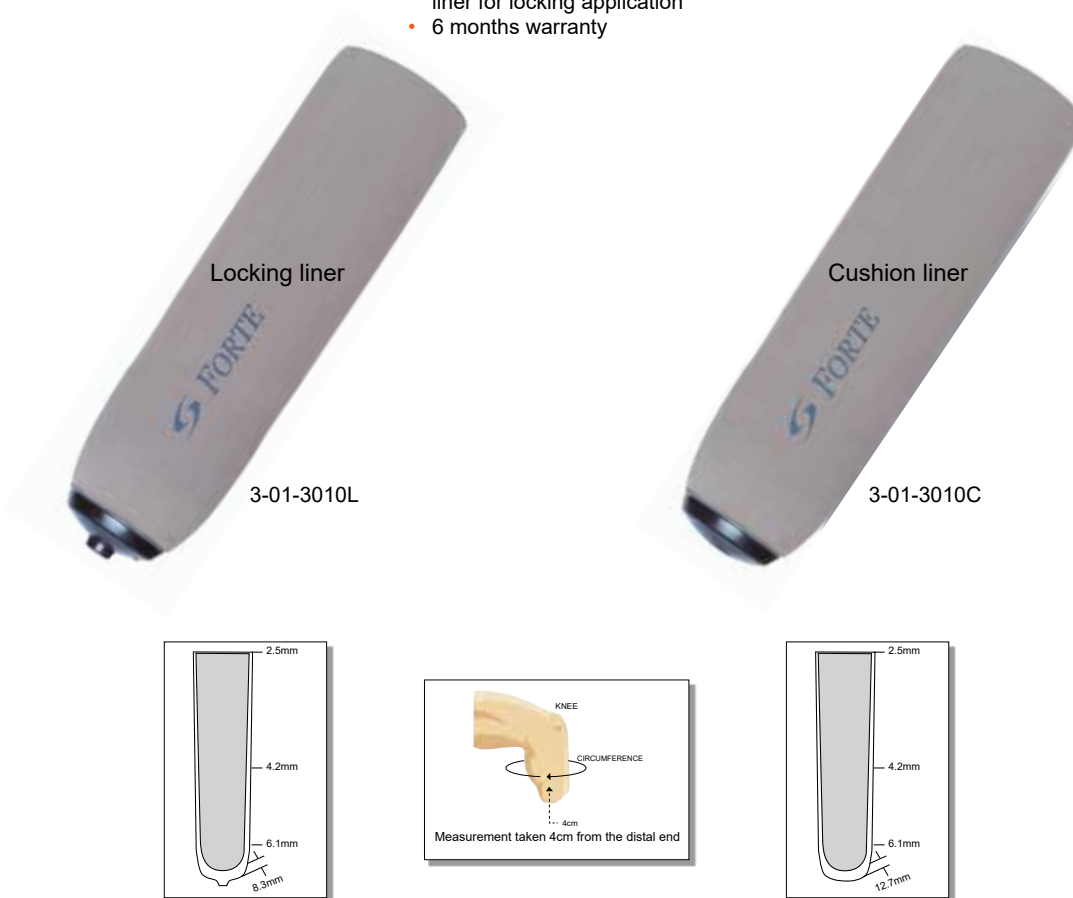

TRANSTIBIAL Locking liner

Product Code	Circumference	Length
3-01-3010L-18	180mm	370mm
3-01-3010L-20	200mm	370mm
3-01-3010L-22	220mm	370mm
3-01-3010L-23.5	235mm	370mm
3-01-3010L-25	250mm	370mm
3-01-3010L-26.5	265mm	370mm
3-01-3010L-28	280mm	370mm
3-01-3010L-30	300mm	370mm
3-01-3010L-32	320mm	370mm
3-01-3010L-34	340mm	370mm
3-01-3010L-36	360mm	370mm

TRANSTIBIAL Cushion liner

Product Code	Circumference	Length
3-01-3010C-18	180mm	360mm
3-01-3010C-20	200mm	360mm
3-01-3010C-22	220mm	360mm
3-01-3010C-23.5	235mm	360mm
3-01-3010C-25	250mm	360mm
3-01-3010C-26.5	265mm	360mm
3-01-3010C-28	280mm	360mm
3-01-3010C-30	300mm	360mm
3-01-3010C-32	320mm	360mm
3-01-3010C-34	340mm	360mm
3-01-3010C-36	360mm	360mm

Pediatric

Feet & Adaptors

Knee joints & Hip Joints

Suspension Systems

Cosmetic, Tools & Materials

Orthotics & Rehabilitation

Upperlimbs Modular Prosthesis

FAQ & Warranty

3-01-3020 TRANSTIBIAL Silicone Liner (BK)

- Parasil Liner offers a superior durable design for your active patient and is available in both PIN LOCKING and CUSHION
- The silky smooth Parasil Liner is designed for high performance with minimal maintenance. Made with platinum cured medical grade mineral oil embedded silicone with a Parylene® coating gives the Parasil the unique ability to repel water and lower the co-efficiency of friction. This hydrophobic property is easy to clean and sanitize leaving it odor free
- The Parylene® surface reduces surface friction between the liner/skin and liner/socket which will help in the prevention of skin shear for fragile skin and blister reduction. The Parasil offers proprietary donning and doffing strips to aid the patient in easier application/removal. It is suitable for moderate to high activity patients who require cushioning over sensitive areas in the socket. The Parasil liner's opaque pigment gives a natural "skin tone" to all ethnic skin types

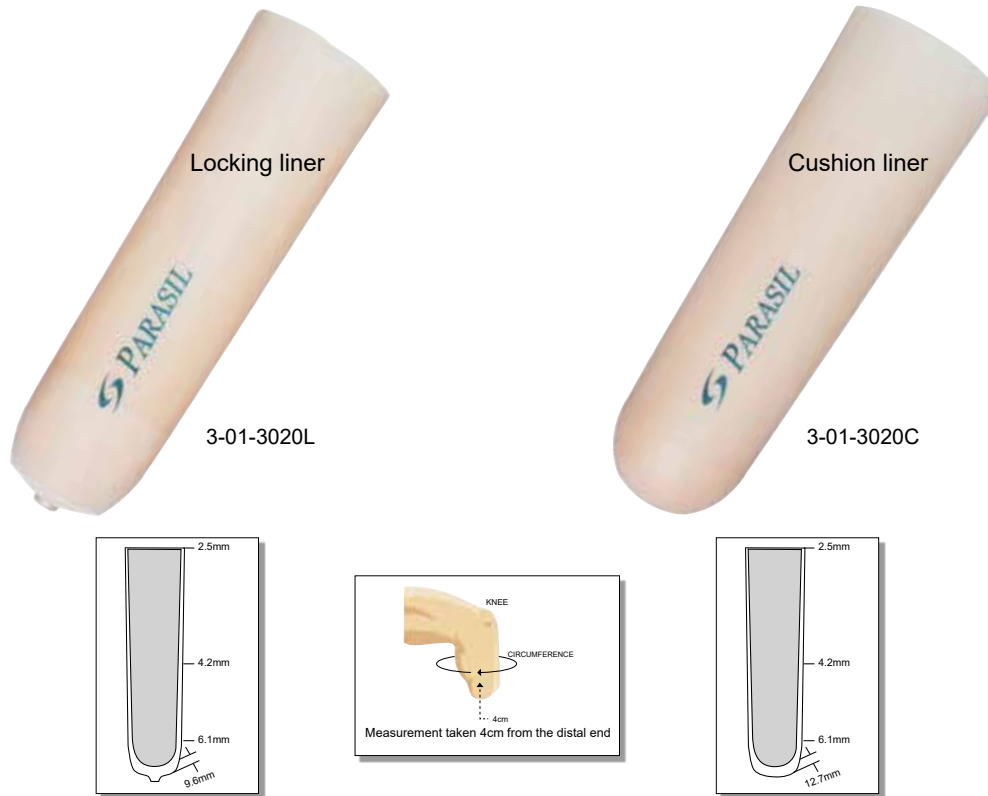

TRANSTIBIAL Locking liner

Product Code	Circumference	Length
3-01-3020L-18	180mm	370mm
3-01-3020L-20	200mm	370mm
3-01-3020L-22	220mm	370mm
3-01-3020L-23.5	235mm	370mm
3-01-3020L-25	250mm	370mm
3-01-3020L-26.5	265mm	370mm
3-01-3020L-28	280mm	370mm
3-01-3020L-30	300mm	370mm
3-01-3020L-32	320mm	370mm
3-01-3020L-34	340mm	370mm
3-01-3020L-36	360mm	370mm

TRANSTIBIAL Cushion liner

Product Code	Circumference	Length
3-01-3020C-18	180mm	360mm
3-01-3020C-20	200mm	360mm
3-01-3020C-22	220mm	360mm
3-01-3020C-23.5	235mm	360mm
3-01-3020C-25	250mm	360mm
3-01-3020C-26.5	265mm	360mm
3-01-3020C-28	280mm	360mm
3-01-3020C-30	300mm	360mm
3-01-3020C-32	320mm	360mm
3-01-3020C-34	340mm	360mm
3-01-3020C-36	360mm	360mm

3-01-3070 TRANSFEMORAL Silicone Liner (AK)

- Parasil Liner offers a superior durable design for your active patient and is available in both PIN LOCKING and CUSHION
- The silky smooth Parasil Liner is designed for high performance with minimal maintenance. Made with platinum cured medical grade mineral oil embedded silicone with a Parylene® coating gives the Parasil the unique ability to repel water and lower the co-efficiency of friction. This hydrophobic property is easy to clean and sanitize leaving it odor free
- The Parylene® surface reduces surface friction between the liner/skin and liner/socket which will help in the prevention of skin shear for fragile skin and blister reduction. The Parasil offers proprietary donning and doffing strips to aid the patient in easier application/removal. It is suitable for moderate to high activity patients who require cushioning over sensitive areas in the socket. The Parasil liner's opaque pigment gives a natural "skin tone" to all ethnic skin types

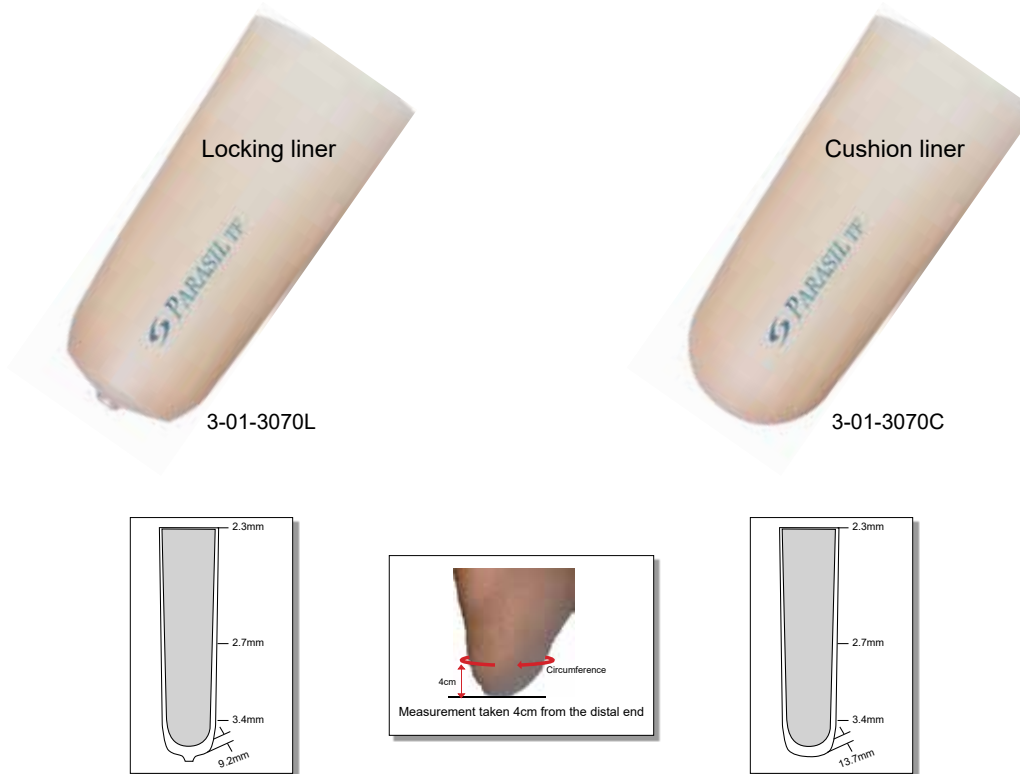

TRANSFEMORAL Locking liner

Product Code	Circumference	Length
3-01-3070L-30	300mm	around 370mm
3-01-3070L-32	320mm	around 370mm
3-01-3070L-34	340mm	around 370mm
3-01-3070L-36	360mm	around 370mm
3-01-3070L-38	380mm	around 370mm
3-01-3070L-40	400mm	around 370mm
3-01-3070L-45	450mm	around 370mm

TRANSFEMORAL Cushion liner

Product Code	Circumference	Length
3-01-3070C-30	300mm	around 370mm
3-01-3070C-32	320mm	around 370mm
3-01-3070C-34	340mm	around 370mm
3-01-3070C-36	360mm	around 370mm
3-01-3070C-38	380mm	around 370mm
3-01-3070C-40	400mm	around 370mm
3-01-3070C-45	450mm	around 370mm

TRANSFEMORAL Silicone Liner – Forte (AK)

3-01-3090L

Pediatric

Feet & Adaptors

Knee joints & Hip Joints

Suspension Systems

Cosmetic, Tools & Materials

Orthotics & Rehabilitation

Upperlimbs Modular Prosthesis

FAQ & Warranty



3-01-3090L

3-01-3090L TRANSFEMORAL Silicone Liner (AK)

- The Forte liner is a silicone gel liner with mineral oil embedded in the silicone providing additional healing factor to the skin. The liner is made of medical grade silicone and durable seamless fabric on the outside for easy donning and doffing application. The liner comes with locking options. It is suitable for low to moderate activity patients. The matrix which is built into the liner prevents distal elongation of the liner for locking application
- 6 months warranty

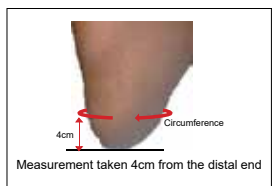

Measurement taken 4cm from the distal end

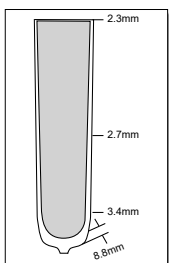

TRANSFEMORAL Locking liner

Product Code	Circumference	Length
3-01-3090L-30	300mm	around 370mm
3-01-3090L-32	320mm	around 370mm
3-01-3090L-34	340mm	around 370mm
3-01-3090L-36	360mm	around 370mm
3-01-3090L-38	380mm	around 370mm
3-01-3090L-40	400mm	around 370mm
3-01-3090L-45	450mm	around 370mm

TRANSFEMORAL Soft Silicone Liner - Adapt

3-01-3092L

New!

3-01-3092L

TRANSFEMORAL Soft Silicone Liner - Adapt

- The ADAPT liner is a silicone gel liner embedded with mineral oil providing skin healing factors. The soft gel with flexible fabric allows snug fit of various contours without restriction. The liner conforms very nicely while providing comfort. It is suitable for moderate to high activity patients. The matrix which is built into the liner prevents distal elongation of the liner for locking application
- 6 months warranty



3-01-3092L

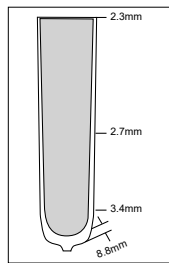
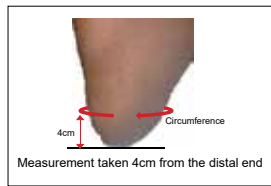

TRANSFEMORAL Locking liner

Product Code	Circumference	Length
3-01-3092L-30	300mm	around 360mm
3-01-3092L-32	320mm	around 360mm
3-01-3092L-34	340mm	around 360mm
3-01-3092L-36	360mm	around 360mm
3-01-3092L-38	380mm	around 360mm
3-01-3092L-40	400mm	around 360mm
3-01-3092L-45	450mm	around 360mm

Pediatric

Feet & Adaptors

Knee joints & Hip Joints

Suspension Systems

Cosmetic, Tools & Materials

Orthotics & Rehabilitation

Upperlimbs Modular Prosthesis

FAQ & Warranty

Pediatric

Feet & Adaptors

Knee joints & Hip Joints

Suspension Systems

Cosmetic, Tools & Materials

Orthotics & Rehabilitation

Upperlimbs Modular Prosthesis

FAQ & Warranty

3-01-3030 TRANSTIBIAL and TRANSFEMORAL Silicone liner (AK/BK)

- It made high shore medical grade silicone
- Design for both AK and BK applications
- Fabric on outside for easy don and doff
- 2 types: Locking and Cushioning
- This liner type very suitable for high activities
- Silicone liners has 44cm length totally and it is useful for long stump
- Anti-Bacterial, Anti-Allergic

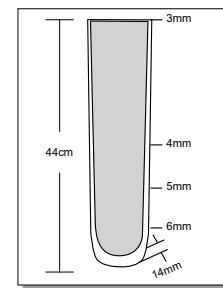
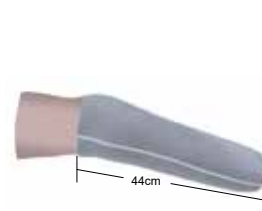
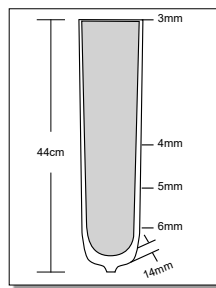
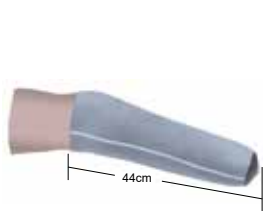
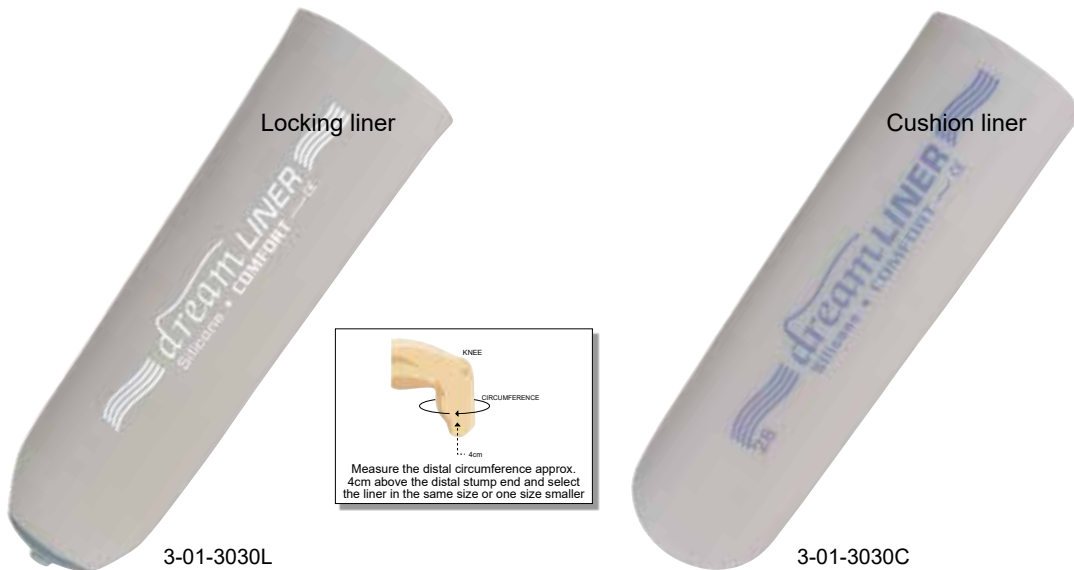

Locking liner

Product Code	Circum.	Thickness	Length
3-01-3030L-21	210mm	3mm	44cm
3-01-3030L-22	220mm	3mm	44cm
3-01-3030L-23.5	235mm	3mm	44cm
3-01-3030L-25	250mm	3mm	44cm
3-01-3030L-26.5	265mm	3mm	44cm
3-01-3030L-28	280mm	3mm	44cm
3-01-3030L-30	300mm	3mm	44cm
3-01-3030L-32	320mm	3mm	44cm
3-01-3030L-34	340mm	3mm	44cm
3-01-3030L-36	360mm	3mm	44cm
3-01-3030L-38	380mm	3mm	44cm
3-01-3030L-40	400mm	3mm	44cm
3-01-3030L-42	420mm	3mm	44cm
3-01-3030L-44	440mm	3mm	44cm

Cushion liner

Product Code	Circum.	Thickness	Length
3-01-3030C-21	210mm	3mm	44cm
3-01-3030C-22	220mm	3mm	44cm
3-01-3030C-23.5	235mm	3mm	44cm
3-01-3030C-25	250mm	3mm	44cm
3-01-3030C-26.5	265mm	3mm	44cm
3-01-3030C-28	280mm	3mm	44cm
3-01-3030C-30	300mm	3mm	44cm
3-01-3030C-32	320mm	3mm	44cm
3-01-3030C-34	340mm	3mm	44cm
3-01-3030C-36	360mm	3mm	44cm
3-01-3030C-38	380mm	3mm	44cm
3-01-3030C-40	400mm	3mm	44cm
3-01-3030C-42	420mm	3mm	44cm
3-01-3030C-44	440mm	3mm	44cm

SHIFT Clutch lock

3-01-SCL/ 3-01-SCL-P



3-01-SCL

3-01-SCL-P



3-01-SCL/3-01-SCL-P SHIFT Clutch lock

- Smooth gear and bearing mechanism for infinite adjustment
- Can be used for laminated and thermoplastic sockets
- Easily compensate for the variance between pin and socket alignment when use with the 4 hole plate
- Quiet Operation

Product Code	Description	Max. Load
3-01-SCL	Shift Clutch Lock	136kg
3-01-SCL-P	Shift Clutch Lock w/Plate	136kg

Refer to "Instructional video" from our website www.regalprosthesis.com

SHIFT Shuttle lock

3-01-SSL/ 3-01-SSL-P



3-01-SSL

3-01-SSL-P



3-01-SSL/3-01-SSL-P SHIFT Shuttle lock

- Serrated pin attachment
- Can be used for laminated and thermoplastic sockets
- Easily compensate for the variance between pin and socket alignment when use with the 4 hole plate

Product Code	Description	Max. Load
3-01-SSL	Shift shuttle Lock	136kg
3-01-SSL-P	Shift shuttle Lock w/Plate	136kg

Refer to "Instructional video" from our website www.regalprosthesis.com

Thread Clutch lock

3-01-TSL



3-01-TSL / 3-01-TSL-S



3-01-TSL-PIN01

3-01-TSL Thread Clutch lock

- Screw in modular design provides easy maintenance
- Cost effective pricing
- Pin length is 60mm. Overall length is 70mm

Product Code	Description	Max. Load
3-01-TSL	Thread Clutch Lock only	100kg
3-01-TSL-S	Thread Clutch lock with Stainless 3 prong rotating base	100kg

Product Code	Description
3-01-TSL-PIN01	Locking pin

Lamination Clutch lock

3-01-LCL



3-01-LCL



3-01-LCL-PIN01

3-01-LCL Lamination Clutch lock

- Smooth gear mechanism
- Quite operation
- All-in-one design
- Design for socket lamination
- Cost effective pricing
- Pin length is 60mm. Overall length is 70mm

Product Code	Description	Max. Load
3-01-LCL	Lamination clutch lock	100kg

Product Code	Description
3-01-LCL-PIN01	Locking pin

Base Shuttle lock

3-01-BSL-00

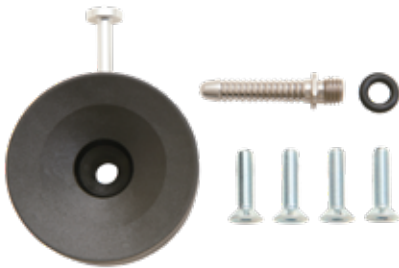

3-01-BSL-00

3-01-BSL-00 Base Shuttle lock

- Made from strong nylon plastic
- Very light design
- Versatile cylindrical body with a 4 hole attachment
- Deep pin well for easy insertion
- Very cost effective



3-01-BSL-01

Product Code	Description	Max. Load
3-01-BSL-00	Base shuttle lock	100kg
3-01-BSL-01	Fabrication Dummy Kit for Shuttle lock	-

Refer to "Instructional video" from our website www.regalprosthesis.com

Pediatric

Feet & Adaptors

Knee joints & Hip Joints

Suspension Systems

Cosmetic, Tools & Materials

Orthotics & Rehabilitation

Upperlimbs Modular Prosthesis

FAQ & Warranty

EZ Adapt lock

3-01-EZL



New!

3-01-EZL EZ Adapt lock

- Low profile modular lock with light weight
- Used with modules, it is easier while extracting the resin during lamination
- Height rotation as needed for easier control on build height
- Pin length: 40mm
- Included lamination dummy
- Available with 3-prong adaptor

Product Code	Description	Weight	Build Height	Max Load.
3-01-EZL	EZ adapt Lock	92g	25mm	136kg

Product Code	Description	Weight	Material	Max Load.
1-02-A11ZS-01	3-prong adaptor	103g	SS	125kg

Easy fit

3-01-EF



3-01-EF Easy fit

- Easy to don the AK socket with valve hole
- Ensures good fit between stump and socket
- Easy to use and carry
- Optimum friction reduction between stump and socket
- Durable
- Can be hand-washed

Product Code	Size	Stump entry circum.
3-01-EF-S	Small	Max 39cm
3-01-EF-M	Medium	Max 48cm
3-01-EF-L	Large	Max 62cm
3-01-EF-XL	X Large	Max 74cm
3-01-EF-XXL	XX Large	Max 82cm

Screw valve for thermoforming technique

3-01-V8



3-01-V8 Screw valve for thermoforming technique

Product Code

3-01-V8

Regal Suspension Systems

XP AK valve

3-01-V7



3-01-V7

3-01-V7 XP AK valve

- Simple installation
- Low build height
- For use any activity level
- Durable

Product Code

3-01-V7

XP BK valve

3-01-V6



3-01-V6

3-01-V6 XP BK valve

- Light weight design
- Low build height
- Easy and quick fabrication
- Easy cleaning

Product Code

3-01-V6

Automatic valve

3-01-V5



3-01-V5

3-01-V5 Automatic valve

Product Code

3-01-V5

Prosthetics rubber valve set

3-01-V4



3-01-V4

3-01-V4 Prosthetics rubber valve with seat ring

Product Code

3-01-V4

Pediatric

Feet &
Adaptors

Knee joints &
Hip Joints

Suspension
Systems

Cosmetic, Tools
& Materials

Orthotics &
Rehabilitation

Upperlimbs
Modular Prosthesis

FAQ & Warranty

Flat rubber valve with tube

3-01-V2



3-01-V2

3-01-V2 Flat rubber valve with tube

Product Code

3-01-V2

Valve kit

3-01-V1

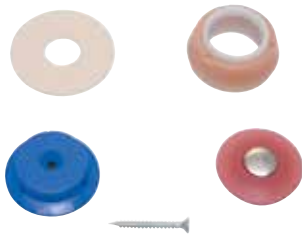

3-01-V1

3-01-V1 Valve kit

Product Code

3-01-V1

AK Suspension sleeve

3-01-AKSS



3-01-AKSS

3-01-AKSS AK-Suspension sleeve

Product Code	Size	Hip size	Socket size	Side
3-01-AKSS-L-S	Small	70-75cm	30-35cm	Left
3-01-AKSS-R-S	Small	70-75cm	30-35cm	Right
3-01-AKSS-L-M	Medium	75-85cm	33-38cm	Left
3-01-AKSS-R-M	Medium	75-85cm	33-38cm	Right
3-01-AKSS-L-L	Large	85-90cm	35-40cm	Left
3-01-AKSS-R-L	Large	85-90cm	35-40cm	Right
3-01-AKSS-L-XL	X Large	95-100cm	38-42cm	Left
3-01-AKSS-R-XL	X Large	95-100cm	38-42cm	Right
3-01-AKSS-L-XXL	XX Large	105-110cm	40-45cm	Left
3-01-AKSS-R-XXL	XX Large	105-110cm	40-45cm	Right
3-01-AKSS-L-XXXL	XXX Large	115-120cm	45-50cm	Left
3-01-AKSS-R-XXXL	XXX Large	115-120cm	45-50cm	Right
3-01-AKSS-L-XXXXL	XXXX Large	125-130cm	53-58cm	Left
3-01-AKSS-R-XXXXL	XXXX Large	125-130cm	53-58cm	Right

Suspension sleeve

3-01-KB



3-01-KB

3-01-KB Suspension sleeve

- Suspension sleeve but not for vacuum
- Two way stretch
- Caucasian skin color

Product Code	Size	Length	Below knee	Knee	Above knee
3-01-KB-S	Small	30.5cm	24.5cm	26cm	27.5cm
3-01-KB-M	Medium	32.5cm	28.5cm	30cm	31.5cm
3-01-KB-L	Large	37.5cm	32cm	34.5cm	36.5cm

Eclipse Silicone Suspension Sleeve

3-01-ECSS



3-01-ECSS

3-01-ECSS Eclipse Silicone Suspension Sleeve

The Eclipse Silicone Suspension Sleeve provides extreme durability and comfort for your patient. Imagine not having to replace suspension sleeves every 3 months. A unique combination of materials and smart design and created a superior suspension sleeve that offers high performance and secure fit.

- Reinforced silicone and strategically located Parylene® coating provides maximum durability
- Dual sleeve design with non-slip inner strip of surface provides a maximum airtight seal which eliminates slippage
- This revolutionary patent pending design helps keep the sleeve in place even during the most strenuous activity
- Depending on activity, the outer Eclipse sleeve easily folds down over itself to reduce the length
- The Parylene® coating does not inhibit knee flexion which allows for excellent performance and comfort
- The Eclipse offers a platinum cured medical grade silicone with a Parylene® surface which reduces surface friction between the sleeve and skin helping in the prevention of skin shear for fragile skin and blister reduction
- The smooth and silky coating allows for clothing to naturally hang and not bunch up
- Warranty: 120 day warranty against defect and workmanship



Measure circumference 15cm (6in) above mid-patella and choose the correct size

Product Code	Color	Set contains	Size
3-01-ECSS-S-BK	Black	Long (outer)+Short (inner)	Small : 41cm – 49cm
3-01-ECSS-M-BK	Black	Long (outer)+Short (inner)	Medium : 49cm – 55cm
3-01-ECSS-L-BK	Black	Long (outer)+Short (inner)	Large : 55cm – 62cm
3-01-ECSS-S-TN	Tan	Long (outer)+Short (inner)	Small : 41cm – 49cm
3-01-ECSS-M-TN	Tan	Long (outer)+Short (inner)	Medium : 49cm – 55cm
3-01-ECSS-L-TN	Tan	Long (outer)+Short (inner)	Large : 55cm – 62cm

Cosmetic, Tools and Materials



Above knee foam cover

4-01-FA

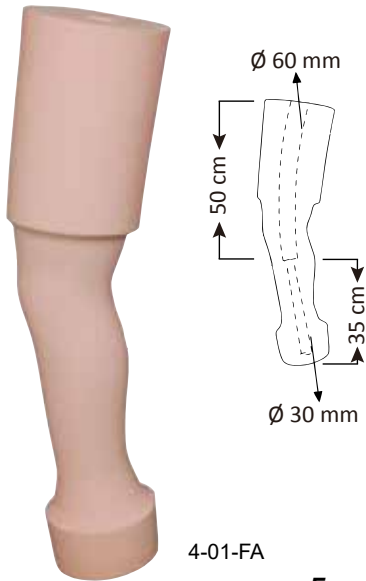

4-01-FA Above knee foam cover

- Durable foam
- 30° knee flexion
- Preshaped
- Center Hole
- Flame Resistant
- Skin Color

Product Code	Calf Circum.	Side	Hole diameter	Length
4-01-FA-L-36	36cm	Left	60-30mm	85cm
4-01-FA-R-36	36cm	Right	60-30mm	85cm
4-01-FA-L-40	40cm	Left	60-30mm	85cm
4-01-FA-R-40	40cm	Right	60-30mm	85cm
4-01-FA-L-44	44cm	Left	60-30mm	85cm
4-01-FA-R-44	44cm	Right	60-30mm	85cm

Foam covers are available in vacuum pack

Knee disarticulation foam cover

4-01-FKD

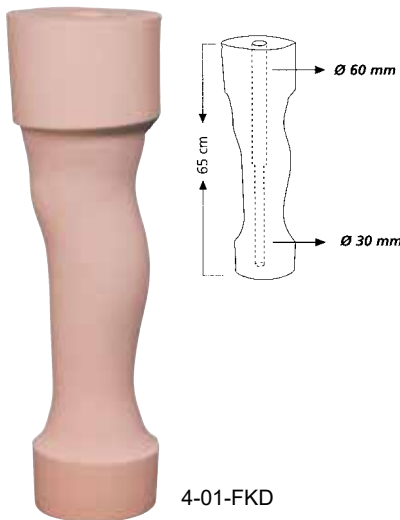

4-01-FKD Knee disarticulation foam cover

- Durable foam
- Preshaped
- Center Hole
- Flame Resistant
- Skin Color

Product Code	Calf Circum.	Side	Hole diameter	Length
4-01-FKD-L-36	36cm	Left	60-30mm	65cm
4-01-FKD-R-36	36cm	Right	60-30mm	65cm
4-01-FKD-L-40	40cm	Left	60-30mm	65cm
4-01-FKD-R-40	40cm	Right	60-30mm	65cm
4-01-FKD-L-44	44cm	Left	60-30mm	65cm
4-01-FKD-R-44	44cm	Right	60-30mm	65cm

Foam covers are available in vacuum pack

Above knee foam cover (pediatric)

0-01-FAC



0-01-FAC Above knee foam cover (pediatric)

- Durable foam
- One size
- 30° knee flexion
- Preshaped
- Center Hole
- Skin Color

Product Code	Calf Circum.	Hole diameter	Length
0-01-FAC	30-22cm	22-30mm	60cm

Foam covers are available in vacuum pack

Below knee foam cover

4-01-FB



4-01-FB

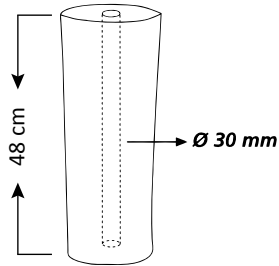

4-01-FB Below knee foam cover

- Durable foam
- One size
- Unshaped
- Center Hole
- Flame Resistant
- Skin Color



Product Code	Hole diameter	Length
4-01-FB	30mm	48cm

Foam covers are available in vacuum pack

Below knee foam cover (pediatric)

0-01-FBC



0-01-FBC

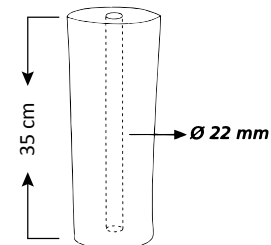

0-01-FBC Below knee foam cover (pediatric)

- Durable foam
- One size
- Unshaped
- Center Hole
- Skin Color

Product Code	Hole diameter	Length
0-01-FBC	22mm	35cm

Foam covers are available in vacuum pack

Foam cover - Plastazote

4-01-FBP



4-01-FBP

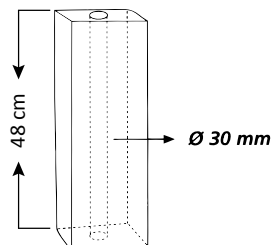

4-01-FBP Foam cover - Plastazote

- Durable foam
- Unshaped
- Center Hole
- Flame Resistant
- Skin Color
- size:160x160x480 mm

Product Code	Hole diameter	Length
4-01-FBP	30mm	48cm

Cosmetic foam cover for upper limb

4-01-FBE

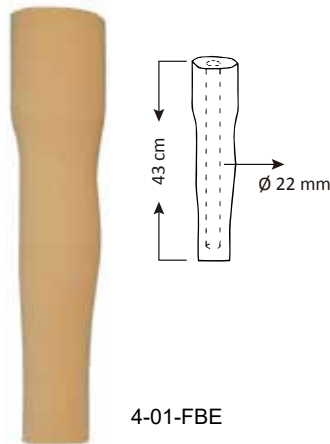

4-01-FBE
Cosmetic foam cover for upper limb below elbow prosthesis

Product Code	Material	Hole diameter	Length
4-01-FBE	Polyurethane	22mm	43cm

Cosmetic foam covers are available in vacuum pack

Cosmetic foam cover for upper limb

4-01-FSD



4-01-FSD
Cosmetic foam cover for upper limb shoulder disarticulation upper part

Product Code	Material	Hole diameter	Length
4-01-FSD	Polyurethane	22mm	43+20cm

Cosmetic foam covers are available in vacuum pack

Cosmetic stockings with foot shape

4-01-AKSTO



4-01-AKSTO
Cosmetic stockings with foot shape

- For AK amputation
- One size
- Total length: 70cm

Product Code

4-01-AKSTO

Cosmetic stockings

4-01-BKSTO



4-01-BKSTO
Cosmetic stockings

- For BK amputation
- One size
- Total length: 45cm

Product Code

4-01-BKSTO

Pediatric

Feet & Adaptors

Knee joints & Hip Joints

Suspension Systems

Cosmetic, Tools & Materials

Orthotics & Rehabilitation

Upperlimbs Modular Prosthesis

FAQ & Warranty

Uni-Grip

4-02-UG



Stops Rotation one strip at a time

4-02-UG Uni-Grip

This unique fabric sheet with pressure sensitive adhesive back provides versatile application for prosthetic and orthotic needs. It's biased direction texture provides grip in one direction while providing free glide in the other direction

- Restrict rotation of stump in AK socket
- Suspension for BK and AK socket
- Restrict migration of orthotics
- Open to other ideas...

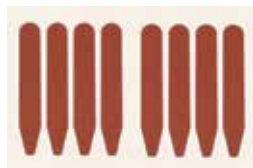

4-02-UG-1

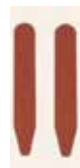

4-02-UG-2

Refer to "Instructional video" from our website www.regalprosthesis.com

Product Code	Description
4-02-UG-1	1 sheet of 8 strips
4-02-UG-2	1 sheet of 2 strips

High quality polyfoam block

4-02-PZ



4-02-PZ

4-02-PZ High quality polyfoam block

- Thermo plastically mouldable at 130°C / 266°F on the heating plate or in the convection oven

Product Code	Thickness	Size
4-02-PZ-3	3mm	2m x 1m
4-02-PZ-6	6mm	2m x 1m
4-02-PZ-12	12mm	2m x 1m

High quality polyfoam

4-02-PF



4-02-PF

4-02-PF High quality polyfoam

- Density 140kg/m³
- Thermo plastically mouldable at 130°C / 266°F on the heating plate or in the convection oven
- Suitable for the production of soft liner sockets

Product Code	Thickness	Size
4-02-PF-2	2mm	2m x 1m
4-02-PF-3	3mm	2m x 1m
4-02-PF-4	4mm	2m x 1m
4-02-PF-5	5mm	2m x 1m
4-02-PF-6	6mm	2m x 1m

Multicolor soft pad

4-02-MP

Pediatric



4-02-MP



4-02-MP Multicolor soft pad

- Thermo plastically moldable at approx. 100-140°C / 212-284°F on the heating plate, and in the oven

Product Code	Thickness	Size	Color
4-02-MP-2-WTBK	2mm	2m x 1m	white black
4-02-MP-4-WTBK	4mm	2m x 1m	white black
4-02-MP-2-PUBK	2mm	2m x 1m	purple black
4-02-MP-4-PUBK	4mm	2m x 1m	purple black
4-02-MP-2-MCOL	2mm	2m x 1m	multi color
4-02-MP-4-MCOL	4mm	2m x 1m	multi color
4-02-MP-2-ARMY	2mm	2m x 1m	army
4-02-MP-4-ARMY	4mm	2m x 1m	army
4-02-MP-2-PKBK	2mm	2m x 1m	pink black
4-02-MP-4-PKBK	4mm	2m x 1m	pink black
4-02-MP-2-BLWT	2mm	2m x 1m	blue white
4-02-MP-4-BLWT	4mm	2m x 1m	blue white
4-02-MP-2-YLBK	2mm	2m x 1m	yellow black
4-02-MP-4-YLBK	4mm	2m x 1m	yellow black

Polypropylene (160° -170°)

4-02-PP

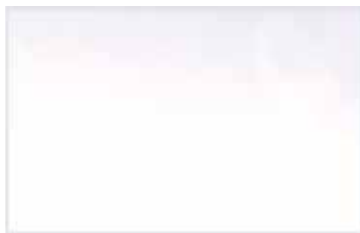

4-02-PP

4-02-PP Polypropylene (160° -170°)

- For use orthotic applications like AFO, corset, splints

Product Code	Thickness	Size	Color
4-02-PP-2	2mm	2m x 1m	White
4-02-PP-3	3mm	2m x 1m	White
4-02-PP-4	4mm	2m x 1m	White
4-02-PP-5	5mm	2m x 1m	White

Polyethylene (160° -170°)

4-02-PE



4-02-PE

4-02-PE Polyethylene (160° -170°)

- For use orthotic applications like AFO, corset, splints

Product Code	Thickness	Size	Color
4-02-PE-2	2mm	2m x 1m	White
4-02-PE-3	3mm	2m x 1m	White
4-02-PE-4	4mm	2m x 1m	White
4-02-PE-5	5mm	2m x 1m	White

Feet & Adaptors

Knee joints & Hip Joints

Suspension Systems

Cosmetic, Tools & Materials

Orthotics & Rehabilitation

Upperlimbs Modular Prosthesis

FAQ & Warranty

Check socket material (160°)

4-02-CSM



4-02-CSM

4-02-CSM Check socket material (160°)

- For BK / AK as for test socket

Product Code	Thickness	Size
4-02-CSM-10	10mm	400 x 400mm
4-02-CSM-12	12mm	400 x 400mm
4-02-CSM-15	15mm	400 x 400mm

Elastomer soft socket material (160°)

4-02-ESM



4-02-ESM

4-02-ESM Elastomer soft socket material (160°)

- For AK prosthetics as an inner soft socket

Product Code	Thickness	Size
4-02-ESM-10	10mm	400 x 400mm
4-02-ESM-12	12mm	400 x 400mm
4-02-ESM-15	15mm	400 x 400mm

Orthotic alignment kit

4-02-OAK



4-02-OAK

4-02-OAK Orthotic alignment kit

Product Code

4-02-OAK

Regal silicone casting material

4-02-CM



4-02-CM

4-02-CM

Regal silicone casting material (for semi-custom made casting only)

- High elasticity
- Good for all types of residual limbs
- 1kg per pail
- To be used with Regal silicone casting material hardener (4-02-CMH)
- Ratio for casting material and casting material hardener is 100g:4g

Product Code

4-02-CM

Regal silicone casting material hardener

4-02-CMH



4-02-CMH

4-02-CMH

Regal silicone casting material hardener

- High elasticity
- Good for all types of stump
- To be used with Regal silicone casting material (4-02-CM)
- 100g per bottle
- Ratio for casting material and casting material hardener is 100g:4g

Product Code

4-02-CMH

Pediatric

Feet &
Adaptors

Knee joints &
Hip Joints

Suspension
Systems

Cosmetic, Tools
& Materials

Orthotics &
Rehabilitation

Upperlimbs
Modular Prosthesis

FAQ & Warranty

Regal premium grade color pigments

4-02-PIG



4-02-PIG

4-02-PIG

Regal premium grade color pigments

- Packaging: 1kg / 100g
- For socket lamination
- For color mixing

Product Code	Color
4-02-PIG-CA-1kg	Caucasian
4-02-PIG-CA-100g	Caucasian
4-02-PIG-BW-1kg	Brown
4-02-PIG-BW-100g	Brown
4-02-PIG-RE-1kg	Red
4-02-PIG-RE-100g	Red
4-02-PIG-BL-1kg	Blue
4-02-PIG-BL-100g	Blue
4-02-PIG-YL-1kg	Yellow
4-02-PIG-YL-100g	Yellow
4-02-PIG-WT-1kg	White
4-02-PIG-WT-100g	White
4-02-PIG-BK-1kg	Black
4-02-PIG-BK-100g	Black

Pediatric

Feet & Adaptors

Knee joints & Hip Joints

Suspension Systems

Flexible PU foam (Premium quality)

4-02-PUFA



4-02-PUFA

4-02-PUFA

Flexible PU foam (Premium quality)

- Premium quality
- mixing ratio: 2 PUFA:1 PUFB
- 1kg per pail

Product Code

4-02-PUFA

Cosmetic, Tools & Materials

Orthotics & Rehabilitation

Upperlimbs Modular Prosthesis

FAQ & Warranty

Flexible PU foam hardener

4-02-PUFB

Pediatric

Feet & Adaptors



4-02-PUFB

4-02-PUFB Flexible PU foam hardener

- Hardener
- Similar to Pedilen Flexible Foam 300
- 1kg per pail

Product Code

4-02-PUFB

Knee joints & Hip Joints

Suspension Systems

Plaster bandages

4-02-PB

Cosmetic, Tools & Materials



4-02-PB

4-02-PB Plaster bandages

- Length 460cm per roll
- Standard quality

Product Code	Width
4-02-PB-75	75mm
4-02-PB-150	150mm

Orthotics & Rehabilitation

Upperlimbs Modular Prosthesis

FAQ & Warranty

NSP braids

4-02-NSP



4-02-NSP

4-02-NSP NSP braids

DYNAMIC STIFFNESS with 10 X THE IMPACT RESISTANC

NSP is a unique natural fiber that is lighter, stronger, offers ½ the stiffness and 10X the impact resistance than carbon. The stiffness can be regulated by fiber orientation to be equal to carbon. NSP can be stiff or flexible depending upon practitioner preference.

NSP wets out fast because of its high fiber interface and low void content. Translated the resin sticks and air does not get trapped easily.

Unlike carbon, NSP is a green eco-friendly natural fiber that creates no flying fibers and no itch which technicians and practitioners love

- Provides great fatigue strength for the socket
- Tested in socket form under ISO guidelines for patients up to 500 lbs
- Available in 3, 4, 5, 6, 8,10 & 12 inch width & 10 and 50 feet length
- NSP = WHITE - 4-02-NSP

Product Code	Description	Width	Length
4-02-NSP-3-10	NSP Braid	3 inch	10 feet
4-02-NSP-3-50	NSP Braid	3 inch	50 feet
4-02-NSP-4-10	NSP Braid	4 inch	10 feet
4-02-NSP-4-50	NSP Braid	4 inch	50 feet
4-02-NSP-5-10	NSP Braid	5 inch	10 feet
4-02-NSP-5-50	NSP Braid	5 inch	50 feet
4-02-NSP-6-10	NSP Braid	6 inch	10 feet
4-02-NSP-6-50	NSP Braid	6 inch	50 feet
4-02-NSP-8-10	NSP Braid	8 inch	10 feet
4-02-NSP-8-50	NSP Braid	8 inch	50 feet
4-02-NSP-10-10	NSP Braid	10 inch	10 feet
4-02-NSP-10-50	NSP Braid	10 inch	50 feet
4-02-NSP-12-10	NSP Braid	12 inch	10 feet
4-02-NSP-12-50	NSP Braid	12 inch	50 feet

NSP with
Extra White
Pigment



NSP with
Green
Pigment



NSP with
BLACK
Pigment



NSP with
Tshirt transfer
design



PLEASE NOTE:

To achieve a custom color like the socket color shown above in lime green – color pigment was added to the process. Many different colors can be created by adding this pigment.

The NSP material can create incredible color combinations when using pigment or tshirt transfer design.

Refer to "Instructional video" from our website www.regalprosthesis.com

NSP Uni-directional 3K tape

4-02-NSP-3K



4-02-NSP-3K

4-02-NSP-3K NSP Uni-directional 3K tape

Designed to enhance longitudinal and brim strength and stiffness

NSP Unidirectional tape is a green eco-friendly natural fiber that creates no flying fibers and no itch

- Provides great fatigue strength for the socket
- Green eco-friendly natural fiber
- Is lighter than carbon tape
- Is stronger than carbon tape
- ½ the stiffness of carbon tape
- Offers 10x the impact resistance than carbon tape
- Keeps labs clean due to enhanced fiber saturation
- No itch
- Tested in socket form under ISO guidelines for patients up to 500 lbs

Product Code	Description	Width	Length
4-02-NSP-3K-1-30	NSP Uni-directional 3k tape	1 inch	30 feet
4-02-NSP-3K-3-30	NSP Uni-directional 3k tape	3 inch	30 feet

Carbon braid

4-02-C-TB



4-02-C-TB

4-02-C-TB Carbon braid

- 12K Strand Count
- Designed for improved polyester and fiber interface
- Decreased fraying (less dust)

Product Code	Description	Width	Length
4-02-C-TB-3-10	Carbon Tube Braid	3 inch	10 feet
4-02-C-TB-3-50	Carbon Tube Braid	3 inch	50 feet
4-02-C-TB-4-10	Carbon Tube Braid	4 inch	10 feet
4-02-C-TB-4-50	Carbon Tube Braid	4 inch	50 feet
4-02-C-TB-5-10	Carbon Tube Braid	5 inch	10 feet
4-02-C-TB-5-50	Carbon Tube Braid	5 inch	50 feet
4-02-C-TB-6-10	Carbon Tube Braid	6 inch	10 feet
4-02-C-TB-6-50	Carbon Tube Braid	6 inch	50 feet
4-02-C-TB-8-10	Carbon Tube Braid	8 inch	10 feet
4-02-C-TB-8-50	Carbon Tube Braid	8 inch	50 feet
4-02-C-TB-10-10	Carbon Tube Braid	10 inch	10 feet
4-02-C-TB-10-50	Carbon Tube Braid	10 inch	50 feet

Pediatric

Feet & Adaptors

Knee joints & Hip Joints

Suspension Systems

Cosmetic, Tools & Materials

Orthotics & Rehabilitation

Upperlimbs Modular Prosthesis

FAQ & Warranty



4-02-PARALEX-TB



4-02-PARALEX-TB PARALEX carbon + NSP tube braid

Combining the world's highest tech fibers...

- PARALEX = CARBON +NSP
- = Stiffness + Strength
- = 1/2 the weight
- = Thin Laminations
- = Durability

- The NSP material within the Paralex can create incredible color combinations when using pigment

Cutting PARALEX Fiber:

- Before cutting PARALEX fiber, tape the edge of the fiber with masking tape then cut down the middle of the tape line.
- Use a scissor with a serrated edge.
- If you attempt to cut PARALEX fiber with a smooth bladed scissor, use very sharp scissors then fold the braid over on itself-(doubling up) greatly helps

Lamination:

- For the best edging results, the use of Perlon, nylons or 1/2oz Dacron felt is ideal as the first layer and the last layer.

For best results use 80:20 resin

Grinding:

- Use high speed and low pressure.
- Only use sharp abrasives, dull abrasives will create friction and will "burn off" the resin and leave exposed fibers at your edge

PARALEX Technical Data

Edging Techniques:

(The use of inner and outer finish layers is required. See example layups below)

Finishing edge instructions:

Finish as you would any composite by wet sanding using 220 grit and finish with 400 grit wet/dry sanding paper.

Example Layup TT:

- Typical TT
- 1 layer of 1/2oz felt or 2 layers of Perlon or nylon
- 1 layer of PARALEX
- 2 layers of Nyglassor equivalent.
- 1 layer of PARALEX
- 2 layers of sheer nylon or equivalent

Example Layup TF:

- Typical TF
- 1 layer of 1/2oz felt or 2 layers of Perlon or nylon
- 1 layer of PARALEX
- 2 layers of Nyglassor equivalent.
- 1 layer of PARALEX
- 2 layers of sheer nylon or equivalent

Product Code	Description	Width	Length
4-02-PARALEX-TB-3-10	PARALEX Carbon + NSP Tube Braid	3 inch	10 feet
4-02-PARALEX-TB-3-50	PARALEX Carbon + NSP Tube Braid	3 inch	50 feet
4-02-PARALEX-TB-4-10	PARALEX Carbon + NSP Tube Braid	4 inch	10 feet
4-02-PARALEX-TB-4-50	PARALEX Carbon + NSP Tube Braid	4 inch	50 feet
4-02-PARALEX-TB-5-10	PARALEX Carbon + NSP Tube Braid	5 inch	10 feet
4-02-PARALEX-TB-5-50	PARALEX Carbon + NSP Tube Braid	5 inch	50 feet
4-02-PARALEX-TB-6-10	PARALEX Carbon + NSP Tube Braid	6 inch	10 feet
4-02-PARALEX-TB-6-50	PARALEX Carbon + NSP Tube Braid	6 inch	50 feet
4-02-PARALEX-TB-8-10	PARALEX Carbon + NSP Tube Braid	8 inch	10 feet
4-02-PARALEX-TB-8-50	PARALEX Carbon + NSP Tube Braid	8 inch	50 feet
4-02-PARALEX-TB-10-10	PARALEX Carbon + NSP Tube Braid	10 inch	10 feet
4-02-PARALEX-TB-10-50	PARALEX Carbon + NSP Tube Braid	10 inch	50 feet

Ultra6 carbon tube braid

4-02-ULTC-TB

Pediatric

Feet & Adaptors

Knee joints & Hip Joints

Suspension Systems

Cosmetic, Tools & Materials

Orthotics & Rehabilitation

Upperlimbs Modular Prosthesis

FAQ & Warranty



4-02-ULTC-TB



4-02-ULTC-TB Ultra6 carbon tape braid

- Light, Durable & Strong
- Very conforming
- Wets out nicely for a smoother finish
- Comparable cost to standard carbon
- Thinner and lighter than standard carbon without sacrificing strength

Product Code	Description	Width	Length
4-02-ULTC-TB-3-10	Ultra6 carbon tube braid	3 inch	10 feet
4-02-ULTC-TB-3-50	Ultra6 carbon tube braid	3 inch	50 feet
4-02-ULTC-TB-4-10	Ultra6 carbon tube braid	4 inch	10 feet
4-02-ULTC-TB-4-50	Ultra6 carbon tube braid	4 inch	50 feet
4-02-ULTC-TB-5-10	Ultra6 carbon tube braid	5 inch	10 feet
4-02-ULTC-TB-5-50	Ultra6 carbon tube braid	5 inch	50 feet
4-02-ULTC-TB-6-10	Ultra6 carbon tube braid	6 inch	10 feet
4-02-ULTC-TB-6-50	Ultra6 carbon tube braid	6 inch	50 feet
4-02-ULTC-TB-8-10	Ultra6 carbon tube braid	8 inch	10 feet
4-02-ULTC-TB-8-50	Ultra6 carbon tube braid	8 inch	50 feet
4-02-ULTC-TB-10-10	Ultra6 carbon tube braid	10 inch	10 feet
4-02-ULTC-TB-10-50	Ultra6 carbon tube braid	10 inch	50 feet

Ultra6 carbon tape

4-02-ULTC-TP



4-02-ULTC-TP

4-02-ULTC-TP Ultra6 carbon tape

- New lighter weight unidirectional carbon tape for optimum strength

Product Code	Description	Width	Length
4-02-ULTC-TP-1-30	Ultra6 Carbon Tape	1 inch	30 feet
4-02-ULTC-TP-3-30	Ultra6 Carbon Tape	3 inch	30 feet
4-02-ULTC-TP-3-100	Ultra6 Carbon Tape	3 inch	100 feet

Cotton stockinette

4-02-STO-COT



4-02-STO-COT

4-02-STO-COT Cotton stockinette

- For reinforcement of laminating resins

Product Code	Width	Weight	Length
4-02-STO-COT-060	60mm	1kg / roll	~29m / roll
4-02-STO-COT-090	90mm	1kg / roll	~20m / roll
4-02-STO-COT-130	130mm	1kg / roll	~14m / roll
4-02-STO-COT-150	150mm	1kg / roll	~12m / roll
4-02-STO-COT-250	250mm	1kg / roll	~7m / roll
4-02-STO-COT-300	300mm	1kg / roll	~6m / roll

Fiberglass stockinette

4-02-STO-FG



4-02-STO-FG

4-02-STO-FG Fiberglass stockinette

- For reinforcement of laminating resins
- Highly elastic
- Blend of fiberglass

Product Code	Width	Weight	Length
4-02-STO-FG-060	60mm	1kg / roll	~40m / roll
4-02-STO-FG-080	80mm	1kg / roll	~48m / roll
4-02-STO-FG-090	90mm	1kg / roll	~35m / roll
4-02-STO-FG-100	100mm	1kg / roll	~35m / roll
4-02-STO-FG-120	120mm	1kg / roll	~27m / roll
4-02-STO-FG-130	130mm	1kg / roll	~30m / roll
4-02-STO-FG-150	150mm	1kg / roll	~20m / roll
4-02-STO-FG-180	180mm	1kg / roll	~20m / roll
4-02-STO-FG-200	200mm	1kg / roll	~15m / roll
4-02-STO-FG-250	250mm	1kg / roll	~15m / roll

Polypropylene stockinette

4-02-STO-POL



4-02-STO-POL

4-02-STO-POL Polypropylene stockinette

- Very Similar to Perion stockinette
- For reinforcement of laminating resins
- Very elastic

Product Code	Width	Weight	Length
4-02-STO-POL-060	60mm	1kg / roll	~48m / roll
4-02-STO-POL-080	80mm	1kg / roll	~42m / roll
4-02-STO-POL-090	90mm	1kg / roll	~40m / roll
4-02-STO-POL-100	100mm	1kg / roll	~38m / roll
4-02-STO-POL-120	120mm	1kg / roll	~34m / roll
4-02-STO-POL-130	130mm	1kg / roll	~30m / roll
4-02-STO-POL-150	150mm	1kg / roll	~28m / roll
4-02-STO-POL-180	180mm	1kg / roll	~25m / roll
4-02-STO-POL-200	200mm	1kg / roll	~23m / roll
4-02-STO-POL-240	240mm	1kg / roll	~17m / roll
4-02-STO-POL-250	250mm	1kg / roll	~16m / roll

Premium quality PVA film

4-02-PVA-P

Pediatric



4-02-PVA-P Premium quality PVA film

4-02-PVA-P

Product Code	Width	Thickness	Length
4-02-PVA-P100	1000mm	0.05mm	100m

Economy PVA film

4-02-PVA-E

Feet & Adaptors



4-02-PVA-E Economy PVA film

4-02-PVA-E

Product Code	Width	Thickness	Length
4-02-PVA-E50	1114mm	0.08mm	50m
4-02-PVA-E100	1114mm	0.08mm	100m

PVA bag

4-02-PVAB

Knee joints & Hip Joints



4-02-PVAB PVA bag

- With conical shape for acrylic and polyester laminating resins
- Thickness : 0.08mm
- Water soluble
- 10pcs per pack

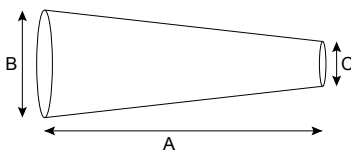

4-02-PVAB

Product Code	Dimension A	Dimension B	Dimension C
4-02-PVAB-XS	600mm	130mm	40mm
4-02-PVAB-S	700mm	190mm	50mm
4-02-PVAB-M	700mm	270mm	50mm
4-02-PVAB-L	1000mm	190mm	50mm
4-02-PVAB-XL	1000mm	260mm	50mm

Suspension Systems

Cosmetic, Tools & Materials

Orthotics & Rehabilitation

Upperlimbs Modular Prosthesis

FAQ & Warranty

Regal Silicone putty

4-02-SP



4-02-SP Regal Silicone putty

- It uses for casting purpose

Product Code	Description	Net Contents
4-02-SP-A	Silicone putty (Base)	500 ml
4-02-SP-B	Silicone putty (Catalyst)	500 ml

Pediatric

Feet & Adaptors

Knee joints & Hip Joints

Suspension Systems

Cosmetic, Tools & Materials

Orthotics & Rehabilitation

Upperlimbs Modular Prosthesis

FAQ & Warranty

Connection cap for Regal single axis foot

1-01-FT-01

Pediatric

Feet & Adaptors

Knee joints & Hip Joints

Suspension Systems

Cosmetic, Tools & Materials

Orthotics & Rehabilitation

Upperlimbs Modular Prosthesis

FAQ & Warranty



1-01-FT-01

1-01-FT-01 Connection cap for Regal single axis foot

Product Code	Size
1-01-FT-01-21	21cm
1-01-FT-01-22	22cm
1-01-FT-01-23	23cm
1-01-FT-01-24	24cm
1-01-FT-01-25	25cm
1-01-FT-01-26	26cm
1-01-FT-01-27	27cm
1-01-FT-01-28	28cm

Connection plate for Regal SACH foot

1-01-FTT-01



1-01-FTT-01

1-01-FTT-01 Connection plate for Regal SACH foot

- Glue to Regal cosmetic foam cover

Product Code
1-01-FTT-01

Grease pencil

4-02-GP

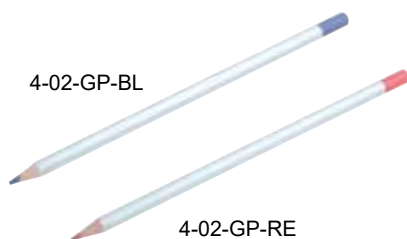

4-02-GP-BL

4-02-GP-RE

4-02-GP Grease pencil

- For marks on wet plaster molds and plaster casts
- 10 pcs per pack

Product Code	Color
4-02-GP-BL	Blue
4-02-GP-RE	Red

Plastic loop

4-02-PL



4-02-PL Plastic loop

- 50 pcs per box

Product Code	Size	Width (inner loop)
4-02-PL-1	Small	2.5cm
4-02-PL-2	Large	3.8cm

Pediatric

Feet & Adaptors

Plastic bolt

4-02-PBOLT

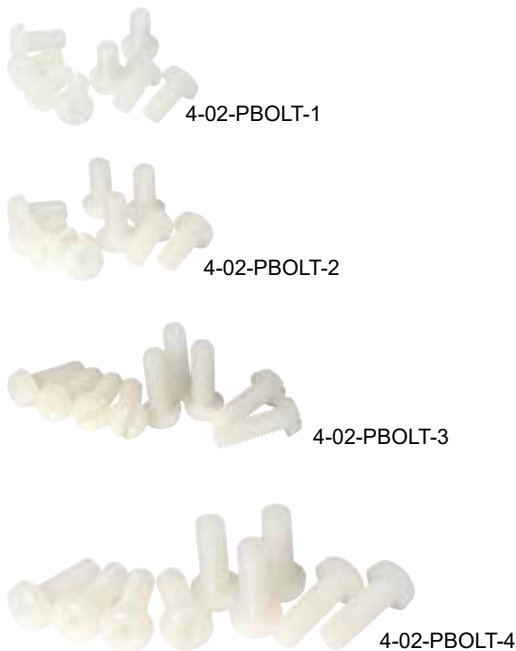

4-02-PBOLT Plastic bolt

- 50 pcs per box

Product Code	Size
4-02-PBOLT-1	M5 x 15
4-02-PBOLT-2	M5 x 20
4-02-PBOLT-3	M6 x 16
4-02-PBOLT-4	M6 x 20

Knee joints & Hip Joints

Suspension Systems

Cosmetic, Tools & Materials

Orthotics & Rehabilitation

Pipe cutter

4-02-PC



4-02-PC

4-02-PC Pipe cutter

- cut tube size (3-32mm)
- Suitable for stainless steel, aluminium and copper tube

Product Code
4-02-PC

Upperlimbs Modular Prosthesis

FAQ & Warranty

Wooden spatula

4-02-WS

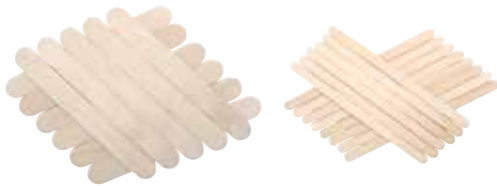

4-02-WS-150

4-02-WS-160

4-02-WS Wooden spatula

- Beech wood
- 50 pcs per pack

Product Code	Length	Width	Thickness
4-02-WS-150	150mm	18mm	1.6mm
4-02-WS-160	160mm	10mm	2mm

Thread locker

4-02-LOC243/ 4-02-LOC271



4-02-LOC243

4-02-LOC271

4-02-LOC243/4-02-LOC271 Thread locker

- Designed for precision metal fasteners
- Protect threads from rust and corrosion

Product Code	Net Contents	Strength
4-02-LOC243	50ml / bott	Medium
4-02-LOC271	50ml / bott	Strong

Medical adhesive

4-02-MAD



4-02-MAD

4-02-MAD Medical adhesive

- Spray form
- Very good medical grade adhesive for holding silicone prostheses onto the stump

Product Code

4-02-MAD

Skin Tac

4-02-LAD120



4-02-LAD120

4-02-LAD120 Skin Tac

- Liquid Form
- Very good medical grade adhesive for holding silicone prostheses onto the stump

Product Code

4-02-LAD120

Sanding drum

4-02-SD



4-02-SD01



4-02-SD02M / 4-02-SD02I



4-02-SD03M / 4-02-SD03I

4-02-SD Sanding drum

- Sanding tools for routers

Product Code	Size	Thread
4-02-SD01	Φ72.5 x L200mm	-
4-02-SD02M	Φ45 x L70mm	M16
4-02-SD02I	Φ45 x L70mm	5/8 inch
4-02-SD03M	Φ25 x L45mm	M16
4-02-SD03I	Φ25 x L45mm	5/8 inch

Rash head

4-02-RHB



4-02-RHB001M

4-02-RHB002M



4-02-RHB003M

4-02-RHB004M

4-02-RHB Rash head

- Sanding tools for routers

Product Code	Size	Thread
4-02-RHB001M	Φ28 x L90mm	M16
4-02-RHB002M	Φ40 x L77mm	M16
4-02-RHB003M	Φ36 x L60mm	M16
4-02-RHB004M	Φ50 x L60mm	M16

Sanding sleeve

4-02-SL



4-02-SL01



4-02-SL02



4-02-SL03

4-02-SL Sanding sleeve

Product Code	Size	Grit #	Compatible with
4-02-SL01-040	Φ72.5 x L200mm	40	4-02-SD01
4-02-SL01-060	Φ72.5 x L200mm	60	4-02-SD01
4-02-SL01-080	Φ72.5 x L200mm	80	4-02-SD01
4-02-SL01-100	Φ72.5 x L200mm	100	4-02-SD01
4-02-SL02-040	Φ45 x L70mm	40	4-02-SD02
4-02-SL02-060	Φ45 x L70mm	60	4-02-SD02
4-02-SL02-080	Φ45 x L70mm	80	4-02-SD02
4-02-SL02-100	Φ45 x L70mm	100	4-02-SD02
4-02-SL03-060	Φ25 x L45mm	60	4-02-SD03
4-02-SL03-080	Φ25 x L45mm	80	4-02-SD03
4-02-SL03-100	Φ25 x L45mm	100	4-02-SD03

4-02-WC

Friction wrist connector for prosthetic socket lamination

- Constant friction applied with a unique friction adjustment collar
- Consists of:
 - a friction unit connector (choice of M12x1.5 or 1/2"-20)
 - a friction adjustment collar
 - a thread stud (choice of M12x1.5 or 1/2"-20)

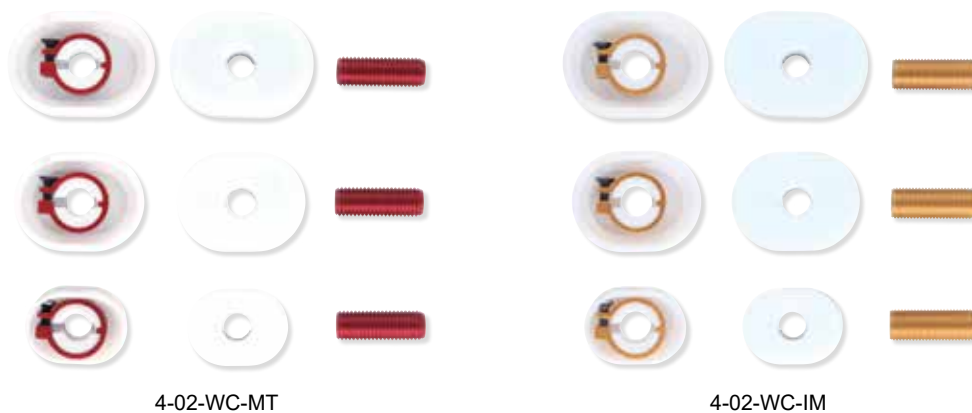

Product Code	Shape	Thread	Stud	Size
4-02-WC-MT-L	Oval shape	M12x1.5	Male/Female	L (55x39x16mm)
4-02-WC-IM-L	Oval shape	1/2"-20	Male/Female	L (55x39x16mm)
4-02-WC-MT-M	Oval shape	M12x1.5	Male/Female	M (49x38x16mm)
4-02-WC-IM-M	Oval shape	1/2"-20	Male/Female	M (49x38x16mm)
4-02-WC-MT-S	Oval shape	M12x1.5	Male/Female	S (38x28x16mm)
4-02-WC-IM-S	Oval shape	1/2"-20	Male/Female	S (38x28x16mm)

Pediatric

Feet & Adaptors

Knee joints & Hip Joints

Suspension Systems

Cosmetic, Tools & Materials

Orthotics & Rehabilitation

Upperlimbs Modular Prosthesis

FAQ & Warranty

Hand Wrist unit with constant friction

4-02-WH

4-02-WH

Hand wrist unit with constant friction

- used for combine modular arm components and hand



4-02-WH

Product Code	Size (Outer diameter (Ø))	Threaded Stud
4-02-WH-MT-40	40mm	M12 x 1.5
4-02-WH-MT-45	45mm	M12 x 1.5
4-02-WH-MT-50	50mm	M12 x 1.5
4-02-WH-IM-40	40mm	1/2"-20
4-02-WH-IM-45	45mm	1/2"-20
4-02-WH-IM-50	50mm	1/2"-20

Pediatric

Feet & Adaptors

Knee joints & Hip Joints

Suspension Systems

Cosmetic, Tools & Materials

Plaster blade handle

4-02-PBHE

4-02-PBHE

Plaster blade handle



4-02-PBHE

Product Code

4-02-PBHE

Orthotics & Rehabilitation

Upperlimbs Modular Prosthesis

FAQ & Warranty

Plaster blade

4-02-PBFL

Pediatric

4-02-PBFL Plaster blade

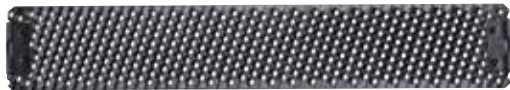

4-02-PBFL

Product Code	Blade Shape	Width
4-02-PBFL	Flat	40mm

Plaster blade

4-02-PBHR

Feet & Adaptors

Knee joints & Hip Joints

4-02-PBHR Plaster blade



4-02-PBHR

Product Code	Blade Shape	Width
4-02-PBHR	Half round	40mm

Plaster blade

4-02-PBRD

Suspension Systems

Cosmetic, Tools & Materials

4-02-PBRD Plaster blade



4-02-PBRD

Product Code	Blade Shape	Diameter
4-02-PBRD	Round	150mm

Orthotics & Rehabilitation

Upperlimbs Modular Prosthesis

FAQ & Warranty

Orthotics and Rehabilitation



Posterior leaf spring AFO

5-01-AFO001



5-01-AFO001

5-01-AFO001 Posterior leaf spring AFO

- The Posterior Leaf Spring AFO fulfills immediate patient care needs, assists with drop foot control
- Provides medial/lateral stability at ankle and can be utilized as an evaluation tool
- This semi-rigid device is manufactured with orthopedic grade polypropylene and a 1½ hook and loop proximal calf strap with a closed cell foam shin pad. Right or left needs to be specified

Product Code	Size	Side	Foot Length
5-01-AFO001-L-S	Small	Left	23cm
5-01-AFO001-R-S	Small	Right	23cm
5-01-AFO001-L-M	Medium	Left	24.5cm
5-01-AFO001-R-M	Medium	Right	24.5cm
5-01-AFO001-L-L	Large	Left	26.5cm
5-01-AFO001-R-L	Large	Right	26.5cm
5-01-AFO001-L-XL	X Large	Left	28cm
5-01-AFO001-R-XL	X Large	Right	28cm

Swedish AFO

5-01-AFO002



5-01-AFO002

5-01-AFO002 Swedish AFO

- The Swedish AFO fulfills immediate patient care needs, assists with drop foot control
- Provides moderate spring assist and can be utilized as an evaluation tool
- This semi-rigid device is manufactured with orthopedic grade polypropylene and a 1½ hook and loop proximal calf strap with a closed cell foam shin pad. Right or left needs to be specified

Product Code	Size	Side	Foot Length
5-01-AFO002-L-S	Small	Left	23cm
5-01-AFO002-R-S	Small	Right	23cm
5-01-AFO002-L-M	Medium	Left	24.5cm
5-01-AFO002-R-M	Medium	Right	24.5cm
5-01-AFO002-L-L	Large	Left	26.5cm
5-01-AFO002-R-L	Large	Right	26.5cm
5-01-AFO002-L-XL	X Large	Left	28cm
5-01-AFO002-R-XL	X Large	Right	28cm

Pediatric

Feet & Adaptors

Knee joints & Hip Joints

Suspension Systems

Cosmetic, Tools & Materials

Orthotics & Rehabilitation

Upperlimbs Modular Prosthesis

FAQ & Warranty

5-01-RF Ridge Flex Ankle Joint



- The RidgeFlex Ankle Joint represents optimal balance between flexibility and rigidity due to the utilization of a proprietary material called Prepalon
- Prepalon is a continuous fiber and elastomer blend technology (CFET)
- The use of flexible elastomer provides optimum tear strength, preventing fatigue failure
- Continuous fiber blended within the elastomer provides structure and rigidity, preventing the joint from stretching
- This technology eliminates the need for strings which do not provide any support in rotation or A-P movement
- Material technology allows for bold concepts which led to the creation of the tendon design. The tendon design offers a smooth movement while providing proper support in the sagittal plane and rotational control
- Combination of flexible elastomer and continuous fiber blend for rigidity allows for optimum balance of smooth movement and rigid support
- No need to compromise the tear strength by using a higher density elastomer for more support. Higher density in elastomer means weaker tear strength, thus compromising the structural integrity of the joint



Product Code	Description	Length	Width
0-01-RFDC200	Pediatric Dorsiflexion Assist	36mm	11mm
0-01-RFSC200	Pediatric Standard	34mm	11mm
0-01-RFSC200DM	Pediatric Dummy – (Dorsiflexion Assist & Standard)		
5-01-RFD100	Dorsiflexion Assist	49mm	15mm
5-01-RFS100	Standard	46mm	15mm
5-01-RFS100DM	Dummy – (Dorsiflexion Assist & Standard)		

Knight armor - Nightsplint

5-01-PFSS

Pediatric

Feet & Adaptors

Knee joints & Hip Joints

Suspension Systems

Cosmetic, Tools & Materials

Orthotics & Rehabilitation

Upperlimbs Modular Prosthesis

FAQ & Warranty

5-01-PFSS Knight armor - Nightsplint



5-01-PFSS

- The Knight Armor provides relief from pain and discomfort of plantar fasciitis and achilles tendonitis
- Applies consistent stretch to plantar fascia by holding foot in desired dorsi-flexion angle
- Dorsi-flexion assist/resist straps, easy push lock buckles, padded forefoot strap, padded proximal calf strap, non-slip walking pad, washable soft-foam liner, light weight design for patient comfort, universal for right or left applications

Product Code	Size
5-01-PFSS-S	Small
5-01-PFSS-M	Medium
5-01-PFSS-L	Large

Ratcheting buckle

5-01-RTB

5-01-RTB Ratcheting buckle



5-01-RTB

- Ratcheting buckle can be used as straps in any orthotic application
- The ratchet design makes it easy for the patient to don the brace with little effort and the quick release enables the patient to doff the brace easily as well
- Two colors are available.

Product Code	Color
5-01-RTB-WT	White
5-01-RTB-BK	Black

Dial lock strap system with hook and loop

5-01-DS100

5-01-DS100 Dial lock strap system with hook and loop



5-01-DS100

- With a 1mm increment adjustment dial, the Dial Lock Strap System with Hook and Loop is designed to allow the patient easy and complete control of the fit and tension between the medical device and residual limb
- Prefabricated and durable
- Adjustable hook and loop closure
- Easy to install
- 100mm (4") of adjustment capability
- Cut to size

Product Code	Width	Usable Strap Max. Length	Usable Strap Min. Length
5-01-DS100	38mm (1.5")	540mm (21.25")	438mm (17.25")

Dial lock strap system with magnetic buckle

5-01-DS200



5-01-DS200

5-01-DS200

Dial lock strap system with magnetic buckle

- With a self-locating and locking magnetic buckle, the Dial Lock Strap System with Magnetic Buckle reduces the wear and tear of repetitive hooking and unhooking
- With a 1mm increment adjustment dial, the system is designed to allow the patient easy and complete control of the fit and tension between the medical device and residual limb
- Self-locating and locking magnetic buckle
- Magnetic buckle rated to 80kg (198lbs)
- Prefabricated and durable
- Adjustable hook and loop closure
- Easy to install
- 100mm (4") of adjustment capability
- Cut to size

Product Code	Width	Usable Strap Max. Length	Usable Strap Min. Length
5-01-DS200	38mm (1.5")	550mm (21.63")	450mm (17.63")

Criss-cross hyperextension spinal orthosis

5-01-RB01



5-01-RB01

5-01-RB01

Criss-cross hyperextension spinal orthosis

- The Criss-Cross hyperextension spinal orthosis reduces risk of additional injury from osteoporosis and compression fractures
- This orthosis is for patients needing moderate control
- The Criss-Cross frame is manufactured from light weight polished aluminum and features an additional adjustment hole for increased height/length and medial/lateral positioning
- This orthosis also features a padded posterior pad with a hook and loop closure system and a slim line thoracic pad for additional comfort and patient compliance
- The Criss-Cross is also a high quality and cost effective product
- Stable, spontaneous or traumatic compression fractures, reducing further injury from osteoporosis or compression during therapy and rehab process

Product Code

5-01-RB01

Spring hinged hyperextension TLSO

5-01-SB01

Pediatric

Feet & Adaptors

Knee joints & Hip Joints

Suspension Systems

Cosmetic, Tools & Materials

Orthotics & Rehabilitation

Upperlimbs Modular Prosthesis

FAQ & Warranty



5-01-SB01 Spring hinged hyperextension TLSO

- The spring hinged hyperextension TLSO features a 3-point pressure control to dynamically maintain leverage for therapeutic immobilization reducing the load on the anterior vertebral bodies
- The single lumbar strap with ratchet buckle creates a snag free closure assisting in patient compliance and ease of donning and doffing. The overall design reduces kyphotic posture associated with compression fractures
- The dynamic extension is accomplished through the spring-hinged design, coupled, with the ratchet locking mechanism creating the 3-point pressure control
- The orthosis also features a lumbar pad, slim line thoracic pad, adjustment for height and M/L and corrosion resistant aluminum frame nicely polished and finished



5-01-SB01

Product Code	Size
5-01-SB01-S	Small
5-01-SB01-M	Medium
5-01-SB01-L	Large
5-01-SB01-XL	X Large

Meridian ankle joint with padding

5-01-MAJ001/ 5-01-MAJKIT

5-01-MAJ001/5-01-MAJKIT Meridian ankle joint with padding

- The Meridian ankle joint is a durable stainless steel ankle joint
- Its sleek and low profile design allows for a light weight and durable ankle joint, which can be set in infinite degrees of motion, without the inconvenience of changing parts
- This joint allows precise degree fine tuning and has the ability to lock in any degree of plantar/dorsi-flexion
- Some uses for the Meridian ankle joint include articulating AFO's, contracture management, solid ankle AFO's, posterior entry AFO's, tone reducing AFO's and floor reaction AFO's



5-01-MAJ001
Meridian Ankle Joint



5-01-MAJKIT
Fabrication Kit

Product Code	Description	Weight Limit
5-01-MAJ001-P	Pediatric (with padding)	50kg (110lbs)
5-01-MAJ001-A	Adult (with padding)	90kg (200lbs)
5-01-MAJ001-HD	Heavy Duty (with padding)	136kg (600lbs)
5-01-MAJKIT-P	Pediatric (padding and positioning rod only)	-
5-01-MAJKIT-A	Adult (padding and positioning rod only)	-
5-01-MAJKIT-HD	Heavy Duty (padding and positioning rod only)	-

PAC Cervical collar

5-01-COL001



5-01-COL001

5-01-COL001 PAC Cervical collar

- Made of light weight closed cell foam material
- Molded and shaped foam helps conform to any patient
- Provides rigid immobilization to cervical spine
- Hook and loop closure for easy adjustment
- Perforated hole for ventilation

Product Code	Size	Circumference	Height
5-01-COL001-2-S	Small	10-13 inch	2.25 inch
5-01-COL001-2-M	Medium	13-16 inch	2.25 inch
5-01-COL001-2-L	Large	16-19 inch	2.25 inch
5-01-COL001-2-XL	X-Large	19-22 inch	2.25 inch
5-01-COL001-3-S	Small	10-13 inch	3.25 inch
5-01-COL001-3-M	Medium	13-16 inch	3.25 inch
5-01-COL001-3-L	Large	16-19 inch	3.25 inch
5-01-COL001-3-XL	X-Large	19-22 inch	3.25 inch
5-01-COL001-4-S	Small	10-13 inch	4.25 inch
5-01-COL001-4-M	Medium	13-16 inch	4.25 inch
5-01-COL001-4-L	Large	16-19 inch	4.25 inch
5-01-COL001-4-XL	X-Large	19-22 inch	4.25 inch
5-01-COL001-5-S	Small	10-13 inch	5.25 inch
5-01-COL001-5-M	Medium	13-16 inch	5.25 inch
5-01-COL001-5-L	Large	16-19 inch	5.25 inch
5-01-COL001-5-XL	X-Large	19-22 inch	5.25 inch

Pediatric

Feet & Adaptors

Knee joints & Hip Joints

Suspension Systems

Cosmetic, Tools & Materials

Orthotics & Rehabilitation

Upperlimbs Modular Prosthesis

FAQ & Warranty

Ring lock system - Straight

5-01-RLOC



5-01-RLOC

Product Code	Length	Width	Thickness	Weight	Description
5-01-RLOC-SS	900mm	19mm	4mm	1300g	Stainless steel upright bar
5-01-RLOC-AL	900mm	19mm	6mm	850g	Aluminum upright bar

Swiss lock system - Straight

5-01-SLOC



5-01-SLOC

Product Code	Length	Width	Thickness	Weight	Description
5-01-SLOC-SS	850mm	19mm	4mm	1400g	Stainless steel upright bar
5-01-SLOC-AL	850mm	19mm	6mm	900g	Aluminum upright bar

Offset orthotic joint for adult (Stainless Steel)

5-01-OFFS-SS



5-01-OFFS-SS

Product Code	Length	Width	Thickness	Posterior	Description
5-01-OFFS-SS-19-22	850mm	19mm	4mm	22mm	Offset orthotic joint for adult (Stainless Steel)
5-01-OFFS-SS-19-16	850mm	19mm	4mm	16mm	Offset orthotic joint for adult (Stainless Steel)
5-01-OFFS-SS-16-22	850mm	16mm	4mm	22mm	Offset orthotic joint for adult (Stainless Steel)
5-01-OFFS-SS-16-16	850mm	16mm	4mm	16mm	Offset orthotic joint for adult (Stainless Steel)

Pediatric

Feet & Adaptors

Knee joints & Hip Joints

Suspension Systems

Cosmetic, Tools & Materials

Orthotics & Rehabilitation

Upperlimbs Modular Prosthesis

FAQ & Warranty

Ring lock system - Straight (pediatric)

0-01-RLOCC-AL



0-01-RLOCC-AL

Product Code	Length	Width	Thickness	Weight	Description
0-01-RLOCC-AL	740mm	12mm	5mm	400g	Aluminum upright bar

Ring lock system - Straight (pediatric)

0-01-RLOCC-SS



0-01-RLOCC-SS

Product Code	Length	Width	Thickness	Weight	Description
0-01-RLOCC-SS	460mm	12mm	3mm	350g	Stainless steel upright bar

Full length silicone insoles

5-01-FL

5-01-FL Full length silicone insoles

- Made of medical level silicon rubber
- The full length provides all-over pressure relief over a large surface
- Ideal for plantar pain, diabetic feet, heel pain/spurs, metatarsal, arthritis, post-surgical feet and also in sports activities



5-01-FL

Product Code	Size	Length
5-01-FL-XS	XS	238mm
5-01-FL-S	S	248mm
5-01-FL-M	M	266mm
5-01-FL-L	L	277mm
5-01-FL-XL	XL	292mm

3/4 Thin pad silicone insoles

5-01-QL

Pediatric

5-01-QL

3/4 Thin pad silicone insoles

- Made of medical level silicon rubber
- Ideal for dress shoes or pumps
- The metatarsal support helps the realignment of metatarsal heads, relieves serve forefoot discomfort or callus buildup
- The position of the softer and blue chips helps relieve the pain of metatarsal



5-01-QL

Product Code	Size
5-01-QL-S	S
5-01-QL-M	M
5-01-QL-L	L

Silicone heel cups for spurs - Central

5-01-HCC

Feet & Adaptors

Knee joints & Hip Joints

5-01-HCC

Silicone heel cups for spurs - Central

- Made of medical level silicone rubber
- Superior shock absorption to relieve and prevent heel, joint and back pain
- The soft blue dot in the center of the heel provides additional cushioning
- Comfortable and long lasting



5-01-HCC

Product Code	Size
5-01-HCC-S	S
5-01-HCC-M	M
5-01-HCC-L	L

Silicone toe spreader

5-01-TS

Suspension Systems

Cosmetic, Tools & Materials

Orthotics & Rehabilitation

Upperlimbs Modular Prosthesis

FAQ & Warranty

5-01-TS

Silicone toe spreader



5-01-TS

Product Code	Size
5-01-TS-S	S
5-01-TS-M	M
5-01-TS-L	L

Upperlimbs Modular Prosthesis



Regal Upperlimbs Modular Prosthesis

ADAPT X Upper Limb Liner

3-01-6210L

New!

3-01-6210L ADAPT X Upper Limb Liner

- The ADAPT X Upper Limb liner is a silicone gel liner with mineral oil embedded in the silicone providing additional healing factor to the skin. The liner is made of medical grade silicone and durable seamless fabric on the outside for easy donning and doffing application
- Comes with locking option
- Works with 6mm thread lock



3-01-6210L

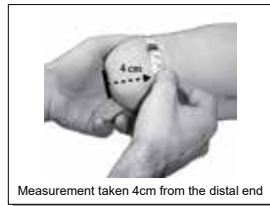

Measurement taken 4cm from the distal end

Product Code	Circumference	Length
3-01-6210L-16	160mm	250mm
3-01-6210L-18	180mm	250mm
3-01-6210L-20	200mm	250mm
3-01-6210L-22	220mm	250mm
3-01-6210L-24	240mm	250mm

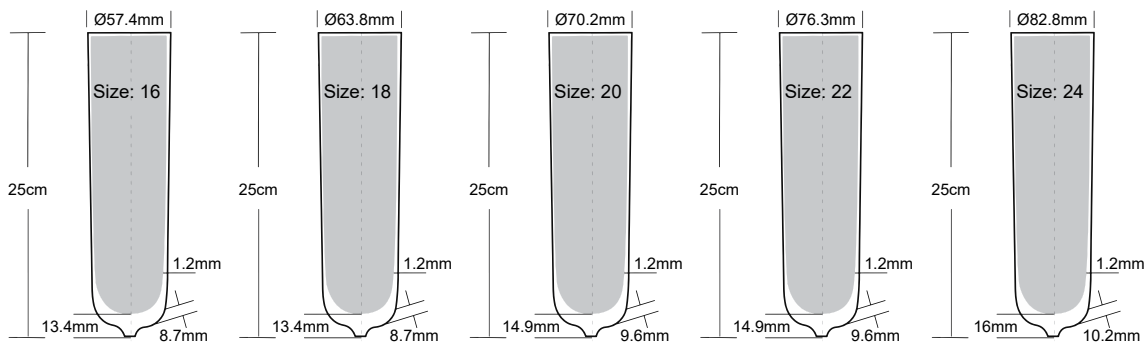

Shell locking elbow joint passive device

6-01-EJ1



6-01-EJ1-CA

6-01-EJ1-DKBW

6-01-EJ1

Shell locking elbow joint passive device

- With passive elbow lock, and upper arm rotation joint

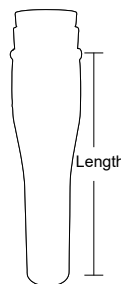

Length

Product Code	Length	Proximal Circumference	Color	Wrist outer diameter	Wrist inner diameter
6-01-EJ1-CA	approx. 287mm	200mm	Caucasian	approx. 54mm	approx. 49mm
6-01-EJ1-DKBW	approx. 287mm	200mm	Dark brown	approx. 54mm	approx. 49mm

Cosmetic prostheses for forearm

6-01-EJ2



6-01-EJ2N

6-01-EJ2N

Cosmetic prostheses for forearm

- For above-elbow residual limb, with passive elbow lock, upper arm and forearm rotation, separate friction
- Main material is aluminum

Product Code	Side	Threaded Stud
6-01-EJ2N-L	Left	M12 x 1.5
6-01-EJ2N-R	Right	M12 x 1.5

Cosmetic prostheses for elbow disarticulation

6-01-EJ3



6-01-EJ3N

6-01-EJ3N

Cosmetic prostheses for elbow disarticulation

- For elbow disarticulation, with passive elbow lock, upper arm and forearm rotation, separate friction
- Main material is aluminum

Product Code	Threaded Stud
6-01-EJ3N	M12 x 1.5

Cosmetic prostheses for shoulder joint

6-01-SJ1



6-01-SJ1N

6-01-SJ1N

Cosmetic prostheses for shoulder joint

- For shoulder disarticulation, with passive elbow lock
- Main material is aluminum

Product Code	Side	Threaded Stud
6-01-SJ1N-L	Left	M12 x 1.5
6-01-SJ1N-R	Right	M12 x 1.5

Pediatric

Feet & Adaptors

Knee joints & Hip Joints

Suspension Systems

Cosmetic, Tools & Materials

Orthotics & Rehabilitation

Upperlimbs Modular Prosthesis

FAQ & Warranty

Mechanical hand - voluntary opening (with PVCIH)

6-02-MH1

Pediatric



6-02-MH1

6-02-MH1 Mechanical hand voluntary opening (with PVCIH)

- With metal cable through the back of the hand (outer pull)
- With threaded stud and inner hand

Feet & Adaptors

Knee joints & Hip Joints

Suspension Systems



Product Code	Side	Size	Threaded stud
6-02-MH1-MT-L-M	Left	M (7 ¼")	M12 x 1.5
6-02-MH1-MT-R-M	Right	M (7 ¼")	M12 x 1.5
6-02-MH1-MT-L-L	Left	L (7 ¾")	M12 x 1.5
6-02-MH1-MT-R-L	Right	L (7 ¾")	M12 x 1.5
6-02-MH1-MT-L-XL	Left	XL (8" - 8 ¼")	M12 x 1.5
6-02-MH1-MT-R-XL	Right	XL (8" - 8 ¼")	M12 x 1.5
6-02-MH1-IM-L-M	Left	M (7 ¼")	1/2"-20
6-02-MH1-IM-R-M	Right	M (7 ¼")	1/2"-20
6-02-MH1-IM-L-L	Left	L (7 ¾")	1/2"-20
6-02-MH1-IM-R-L	Right	L (7 ¾")	1/2"-20
6-02-MH1-IM-L-XL	Left	XL (8" - 8 ¼")	1/2"-20
6-02-MH1-IM-R-XL	Right	XL (8" - 8 ¼")	1/2"-20

Cosmetic, Tools & Materials

Orthotics & Rehabilitation

Upperlimbs Modular Prosthesis

PVC innerhand shell

6-02-PVCIH



6-02-PVCIH

6-02-PVCIH PVC innerhand shell

Product Code	Side	Size
6-02-PVCIH-L-M	Left	M (7 ¼")
6-02-PVCIH-R-M	Right	M (7 ¼")
6-02-PVCIH-L-L	Left	L (7 ¾")
6-02-PVCIH-R-L	Right	L (7 ¾")
6-02-PVCIH-L-XL	Left	XL (8" - 8 ¼")
6-02-PVCIH-R-XL	Right	XL (8" - 8 ¼")

Terms of Sale

- Orders can be cancelled free of charge within 48 hours after the order is confirmed by customers, provided that Regal has not yet shipped the order. Otherwise, order cannot be cancelled once we ship out the order.
- Any orders that are cancelled after 48 hours shall be billed in full amount.
- Subject to the Customer Service approval, customers are allowed to return the goods in brand new conditions due to wrongly ordered or similar situation which are not related to product defects or send the items wrongly by us. 15% restocking fees applies.
- For any quotation on the repairing cost, initial quotation based on the photos is just for reference only. The final quotation is subjected to the receiving of the actual returned products, which may be different from the initial quote.
- Regal reserves the right to make the final determination.

Return Authorization

- Where defects occur, prepare the invoice number and LOT number (and serial number if available) and inform Regal immediately (LOT number and serial number can be found in the product or on the product label);
- Take clear pictures of the damaged area;
- Explain how the damage occurs;
- A Return Authorization (RA) number must be obtained from Regal prior any goods being shipped for repair/ replace/ credit;
- Customers MUST mark the RA number when returning the products;
- Goods return without prior approval or without the Return Authorization (RA) number are subject to refusal and will be returned at the customer's expenses;
- Please inspect all orders immediately upon receipt. Contact Regal within 5 business days in the event of errors or damages;
- Regal reserves the right to make the final determination.

Pediatric

Feet & Adaptors

Knee joints & Hip Joints

Suspension Systems

Cosmetic, Tools & Materials

Orthotics & Rehabilitation

Upperlimbs Modular Prosthesis



Regal Prosthesis Ltd.

Room 3D, Tower F, Mai Luen Industrial Bldg.,
23-31 Kung Yip Street, Kwai Chung, NT, Hong Kong.
T : +852 2771-8991 / 2780 0982 / 3421 1885
F : +852 2384-5948



www.regalprosthesis.com



info@regalprosthesis.com



Regal Prosthesis Limited



Regal Prosthesis Ltd

